

**CITY OF EL PASO, TEXAS
AGENDA ITEM
DEPARTMENT HEAD'S SUMMARY FORM**

DEPARTMENT: Planning & Inspections, Planning Division

AGENDA DATE: March 30, 2021

PUBLIC HEARING DATE: April 13, 2021

CONTACT PERSON NAME AND PHONE NUMBER: Philip F. Etiwe, (915) 212-1553
Luis Zamora, (915) 212-1552

DISTRICT(S) AFFECTED: 2

STRATEGIC GOAL: #3 Promote the Visual Image of El Paso

SUBGOAL: 3.1 Provide business friendly permitting and inspection processes
3.2 Improve the visual impression of the community

SUBJECT:

An Ordinance vacating city right-of-way over Guadalupe Pass Drive Right-of-Way, Hueco Pass Drive Right-of-Way, and Picacho Pass Drive Right-of-Way within Butterfield Trail Aviation Park Unit Three, City of El Paso, El Paso County, Texas

Subject Property: North of Montana Ave. and East of Global Reach Dr.
Applicant: Brock & Bustillos, Inc. SURW21-00001

BACKGROUND / DISCUSSION:

The applicant seeks to vacate the existing Picacho Pass Drive, Hueco Pass Drive, and Guadalupe Pass Drive right-of-ways located within Butterfield Trail Aviation Park Unit Three to allow for construction on the site. City Plan Commission recommended 8-0 to approve the proposed Right-of-Way (ROW) Vacation on February 25, 2021. As of March 23, 2021, staff has received no communication in support or opposition of the request. See attached staff report for additional information.

PRIOR COUNCIL ACTION:

N/A

AMOUNT AND SOURCE OF FUNDING:

N/A

*****REQUIRED AUTHORIZATION*****

DEPARTMENT HEAD:

Philip Etiwe

Philip F. Etiwe – Planning and Inspections Director

ORDINANCE NO. _____

AN ORDINANCE VACATING CITY RIGHT-OF-WAY OVER GUADALUPE PASS DRIVE RIGHT-OF-WAY, HUECO PASS DRIVE RIGHT-OF-WAY, AND PICACHO PASS DRIVE RIGHT-OF-WAY WITHIN BUTTERFIELD TRAIL AVIATION PARK UNIT THREE, CITY OF EL PASO, EL PASO COUNTY, TEXAS

WHEREAS, the abutting property owners have requested vacation of the City right-of-way located on a parcel of land being Guadalupe Pass Drive Right-of-Way, Hueco Pass Drive Right-of-Way, and Picacho Pass Drive Right-of-Way within Butterfield Trail Aviation Park Unit Three, City of El Paso, El Paso County, Texas;and,

WHEREAS, after public hearing the City Plan Commission recommended that Guadalupe Pass Drive Right-of-Way, Hueco Pass Drive Right-of-Way, and Picacho Pass Drive Right-of-Way within Butterfield Trail Aviation Park Unit Three, City of El Paso, El Paso County, Texas, should be vacated and the City Council finds that said right-of-way is not needed for public use and should be vacated as recommended;

NOW, THEREFORE, BE IT ORDAINED BY THE CITY COUNCIL OF THE CITY OF EL PASO:

That a determination has been made that it is in the best interest of the public that the City Right-of-Way located on the property described as a 3.8250 acre parcel situate within the corporate limits of the City of El Paso, El Paso County, Texas as Guadalupe Pass Drive Right-of-Way, a 2.2621 acre parcel situate within the corporate limits of the City of El Paso, El Paso County, Texas as Hueco Pass Drive Right-of-Way, and 3.7979 acre parcel situate within the corporate limits of the City of El Paso, El Paso County, Texas as Picacho Pass Drive Right-of-Way within Butterfield Trail Aviation Park Unit Three, City of El Paso, El Paso County, Texas, and which is more fully described in the attached metes and bounds description, identified as Exhibit "A" and in the attached survey identified as Exhibit "B" and made a part hereof by reference is hereby vacated.

In addition, the City Manager is authorized to sign an instrument quitclaiming all of the City's right, title and interest in and to such vacated property to City of El Paso.

ADOPTED this _____ day of _____, 2021.

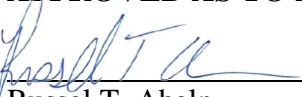
THE CITY OF EL PASO

Oscar Leiser
Mayor

ATTEST:

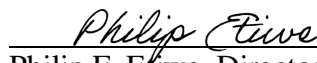
Laura D. Prine, City Clerk

APPROVED AS TO FORM:



Russel T. Abeln
Assistant City Attorney

APPROVED AS TO CONTENT:



Philip F. Efiwe, Director
Planning & Inspections Department

(Quitclaim Deed on following page)

NOTICE OF CONFIDENTIALITY RIGHTS: IF YOU ARE A NATURAL PERSON, YOU MAY REMOVE OR STRIKE ANY OF THE FOLLOWING INFORMATION FROM ANY INSTRUMENT THAT TRANSFERS AN INTEREST IN REAL PROPERTY BEFORE IT IS FILED FOR RECORD IN THE PUBLIC RECORDS: YOUR SOCIAL SECURITY NUMBER OR YOUR DRIVER'S LICENSE NUMBER.

THE STATE OF TEXAS }
} QUITCLAIM DEED

COUNTY OF EL PASO }

That approved by the City Council of the City of El Paso and described as a 3.8250 acre parcel situate within the corporate limits of the City of El Paso, El Paso County, Texas as Guadalupe Pass Drive Right-of-Way, a 2.2621 acre parcel situate within the corporate limits of the City of El Paso, El Paso County, Texas as Hueco Pass Drive Right-of-Way, and 3.7979 acre parcel situate within the corporate limits of the City of El Paso, El Paso County, Texas as Picacho Pass Drive Right-of-Way within Butterfield Trail Aviation Park Unit Three, **CITY OF EL PASO, EL PASO COUNTY, TEXAS**, which is more fully described in the attached metes and bounds in consideration of the receipt by the **CITY OF EL PASO** of Ten Dollars (\$10.00) and other valuable consideration, the sufficiency of which is acknowledged, **THE CITY OF EL PASO**, has released and quitclaimed and by these presents does release and quitclaim unto City of El Paso, (the "Grantee"), all its rights, title, interest, claim and demand in and to the property which was vacated, closed and abandoned by Ordinance No. _____, passed and description, identified as Exhibit "A" and in the attached survey identified as Exhibit "B" and made a part hereof by reference.

WITNESS the following signatures and seal this _____ day of _____, 2021.

CITY OF EL PASO

ATTEST:

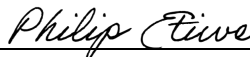
Tomás González, City Manager

Laura D. Prine, City Clerk

APPROVED AS TO FORM:

APPROVED AS TO CONTENT:





Russel T. Abeln
Assistant City Attorney

Philip F. Etiwe, Director
Planning and Inspections Department

(Acknowledgement on following page)

ACKNOWLEDGMENT

THE STATE OF TEXAS)
)
COUNTY OF EL PASO)

This instrument is acknowledged before me on this _____ day of _____, 2021, by Tomás González, as City Manager for the CITY OF EL PASO.

Notary Public, State of Texas
Notary's Printed or Typed Name:

My Commission Expires:

AFTER FILING RETURN TO:
City of EL Paso
300 N. Campbell
El Paso, Texas 79901

Exhibit "A"



ROMAN BUSTILLOS, P.E.
President

RANDY P. BROCK, P.E.
Executive Vice President

SERGIO J. ADAME, P.E.
Vice President - Engineering

AARON ALVARADO, R.P.L.S.
Vice President - Surveying

TBPE Reg. No. F-737
TBPLS Reg. No. 101314-00

METES AND BOUNDS DESCRIPTION (GUADALUPE PASS DRIVE) PARCEL 1

A 3.8250 acre parcel situate within the corporate limits of the City of El Paso, El Paso County, Texas as Guadalupe Pass Drive Right-of-Way within Butterfield Trail Aviation Park Unit Three, as recorded in File No. 2008008611, El Paso County Plat Records and being more particularly described by metes and bounds as follows:

COMMENCING for reference at a city monument found at the centerline intersection of George Perry Boulevard (120 feet wide) and the right-of-way centerline of Guadalupe Pass Drive (76 feet wide); **WHENCE**, a city monument found along the centerline of said George Perry Boulevard and 27.9 feet west of the centerline of Walter Jones Boulevard (180 feet wide) bears, North 45°41'01" East, a distance of 1,577.90 feet; **THENCE**, leaving the centerline of said George Perry Boulevard and following the centerline of said Guadalupe Pass Drive, South 45°14'59" East, a distance of 60.00 feet to the **POINT OF BEGINNING** of the parcel herein described;

THENCE, North 45°41'01" East, a distance of 83.74 feet to the beginning of a non-tangent curve to the left;

THENCE, along the arc of said non-tangent curve to the left having a radius of 45.00 feet, a central angle of 90°56'00", an arc length of 71.42 feet and whose long chord bears South 00°13'01" West, a distance of 64.16 feet to a point of tangency;

THENCE, South 45°14'59" East, a distance of 1,697.15 feet to a point of curvature;

THENCE, along the arc of a curve to the left having a radius of 45.00 feet, a central angle of 55°04'53", an arc length of 43.26 feet and whose long chord bears South 72°47'25" East, a distance of 41.61 feet to a point of reverse curvature;

THENCE, along the arc of a curve to the right having a radius of 100.00 feet, a central angle of 290°09'45", an arc length of 506.43 feet and whose long chord bears South 44°45'01" West, a distance of 114.48 feet to a point of reverse curvature;

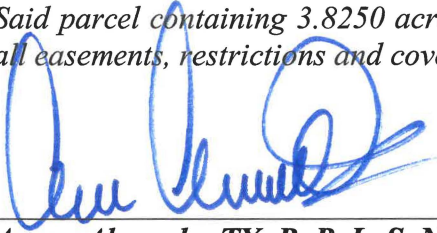
THENCE, along the arc of a curve to the left having a radius of 45.00 feet, a central angle of 55°04'53", an arc length of 43.26 feet and whose long chord bears North 17°42'33" West, a distance of 41.61 feet to a point of tangency;

THENCE, North 45°14'59" West, a distance of 1,699.85 feet to a point of curvature;

THENCE, along the arc of a curve to the left having a radius of 45.00 feet, a central angle of 89°04'00", an arc length of 69.95 feet and whose long chord bears North 89°46'59" West, a distance of 63.12 feet to the end of said curve;

THENCE, North 45°41'01" East, a distance of 82.28 feet to the **POINT OF BEGINNING**.

Said parcel containing 3.8250 acres (166,619.1 square feet), more or less, and being subject to all easements, restrictions and covenants of record.



Aaron Alvarado, TX. R. P. L. S. No. 6223

Date: December 23, 2020

05100-106-ROW VACATION-PARCEL 1-DESC.doc





BROCK & BUSTILLOS INC.
 CIVIL ENGINEERS URBAN DESIGNERS LAND SURVEYORS

Exhibit "A"

ROMAN BUSTILLOS, P.E.
 President
 RANDY P. BROCK, P.E.
 Executive Vice President
 SERGIO J. ADAME, P.E.
 Vice President - Engineering
 AARON ALVARADO, R.P.L.S.
 Vice President - Surveying
 TBPE Reg. No. F-737
 TBPLS Reg. No. 101314-00

METES AND BOUNDS DESCRIPTION (HUECO PASS DRIVE) PARCEL-2

A 2.2621 acre parcel situate within the corporate limits of the City of El Paso, El Paso County, Texas as Hueco Pass Drive Right-of-Way within Butterfield Trail Aviation Park Unit Three, as recorded in File No. 2008008611, El Paso County Plat Records and being more particularly described by metes and bounds as follows:

COMMENCING for reference at a city monument found at the centerline intersection of George Perry Boulevard (120 feet wide) and the right-of-way centerline of Guadalupe Pass Drive (76 feet wide); **WHENCE**, a city monument found along the centerline of said George Perry Boulevard and 27.9 feet west of the centerline of Walter Jones Boulevard (180 feet wide) bears, North 45°41'01" East, a distance of 1,577.90 feet; **THENCE**, leaving the centerline of said George Perry Boulevard and following the centerline of said Guadalupe Pass Drive, South 45°14'59" East, a distance of 60.00 feet; **THENCE**, North 45°41'01" East, a distance of 83.74 feet to the beginning of a non-tangent curve to the left; **THENCE**, along the arc of said non-tangent curve to the left having a radius of 45.00 feet, a central angle of 90°56'00", an arc length of 71.42 feet and whose long chord bears South 00°13'01" West, a distance of 64.16 feet to a point of tangency; **THENCE**, South 45°14'59" East, a distance of 660.51 feet to a point of curvature and the **POINT OF BEGINNING** of the parcel herein described;

THENCE, along the arc of a curve to the left having a radius of 45.00 feet, a central angle of 90°00'00", an arc length of 70.69 feet and whose long chord bears North 89°45'01" East, a distance of 63.64 feet to a point of tangency;

THENCE, North 44°45'01" East, a distance of 790.00 feet to a point of curvature;

THENCE, along the arc of a curve to the left having a radius of 45.00 feet, a central angle of 90°00'00", an arc length of 70.69 feet and whose long chord bears North 00°14'59" West, a distance of 63.64 feet to the end of said curve;

THENCE, South 45°14'59" East, a distance of 200.00 feet to the beginning of a non-tangent curve to the left;

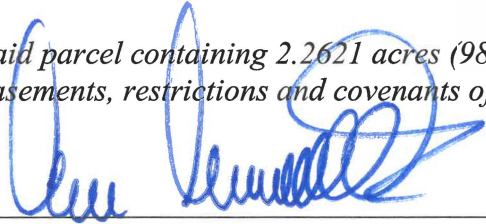
THENCE, along the arc of said non-tangent curve to the left having a radius of 45.00 feet, a central angle of 90°00'00", an arc length of 70.69 feet and whose long chord bears South 89°45'01" West, a distance of 63.64 feet to a point of tangency;

THENCE, South 44°45'01" West, a distance of 790.00 feet a point of curvature;

THENCE, along the arc of a curve to the left having a radius of 45.00 feet, a central angle of 90°00'00", an arc length of 70.69 feet and whose long chord bears South 00°14'59" East, a distance of 63.64 feet to the end of said curve;

THENCE, North 45°14'59" West, a distance of 200.00 feet to the **POINT OF BEGINNING**.

Said parcel containing 2.2621 acres (98,538.3 square feet), more or less, and being subject to all easements, restrictions and covenants of record.



Aaron Alvarado, TX. R. P. L. S. No. 6223

Date: December 23, 2020

05100-106-ROW VACATION-PARCEL 2-DESC.doc



Exhibit "A"



ROMAN BUSTILLOS, P.E.
President

RANDY P. BROCK, P.E.
Executive Vice President

SERGIO J. ADAME, P.E.
Vice President - Engineering

AARON ALVARADO, R.P.L.S.
Vice President - Surveying

TBPE Reg. No. F-737
TBPLS Reg. No. 1013 14-00

METES AND BOUNDS DESCRIPTION (PICACHO PASS DRIVE) PARCEL-3

A 3.7979 acre parcel situate within the corporate limits of the City of El Paso, El Paso County, Texas as Picacho Pass Drive Right-of-Way within Butterfield Trail Aviation Park Unit Three, as recorded in File No. 2008008611, El Paso County Plat Records and being more particularly described by metes and bounds as follows:

COMMENCING for reference at a city monument found at the centerline intersecti of George Perry Boulevard (120 feet wide) and the right-of-way centerline of Guadalupe Pass Drive (76 feet wide); **WHENCE**, a city monument found along the centerline of said George Perry Boulevard and 27.9 feet west of the centerline of Walter Jones Boulevard (180 feet wide) bears, North 45°41'01" East, a distance of 1,577.90 feet; **THENCE**, following the centerli of said George Perry Boulevard, North 45°41'01" East, a distance of 874.83 feet; **THENCE**, leaving the centerline of said George Perry Boulevard, South 44°18'59" East, a distance of 60.00 feet to the **POINT OF BEGINNING** of the parcel herein described;

THENCE, North 45°41'01" East, a distance of 166.02 feet to the beginning of a no curve to the left;

THENCE, along the arc of said non-tangent curve to the left having a radius of 45.00 fea central angle of 90°56'00", an arc length of 71.42 feet and whose long chord bears South 00°13'01" West, a distance of 64.16 feet to a point of tangency;

THENCE, South 45°14'59" East, a distance of 1,681.57 feet to a point of curvature;

THENCE, along the arc of a curve to the left having a radius of 45.00 feet, a central angle of 55° 04'53", an arc length of 43.26 feet and whose long chord bears South 72°47'25" East, a distance of 41.61 feet to a point of reverse curvature;

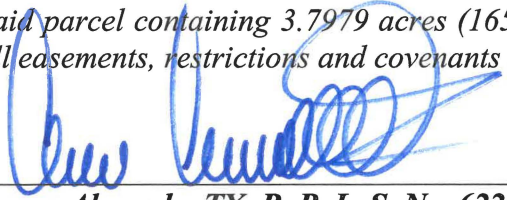
THENCE, along the arc of a curve to the right having a radius of 100.00 feet, a central angle of 290°09'45", an arc length of 506.43 feet and whose long chord bears South 44°45'01" West, a distance of 114.48 feet to a point of reverse curvature;

THENCE, along the arc of a curve to the left having a radius of 45.00 feet, a central angle of 55° 04'53", an arc length of 43.26 feet and whose long chord bears North 17°42'33" West, a distance of 41.61 feet to a point of tangency;

THENCE, North 45°14'59" West, a distance of 1,684.27 feet to a point of curvature;

THENCE, along the arc of a curve to the left having a radius of 45.00 feet, a central angle of 90°00'00", an arc length of 70.69 feet and whose long chord bears South 89°45'01" West, a distance of 63.64 feet to the **POINT OF BEGINNING**.

Said parcel containing 3.7979 acres (165,435.2 square feet), more or less, and being subject to all easements, restrictions and covenants of record.



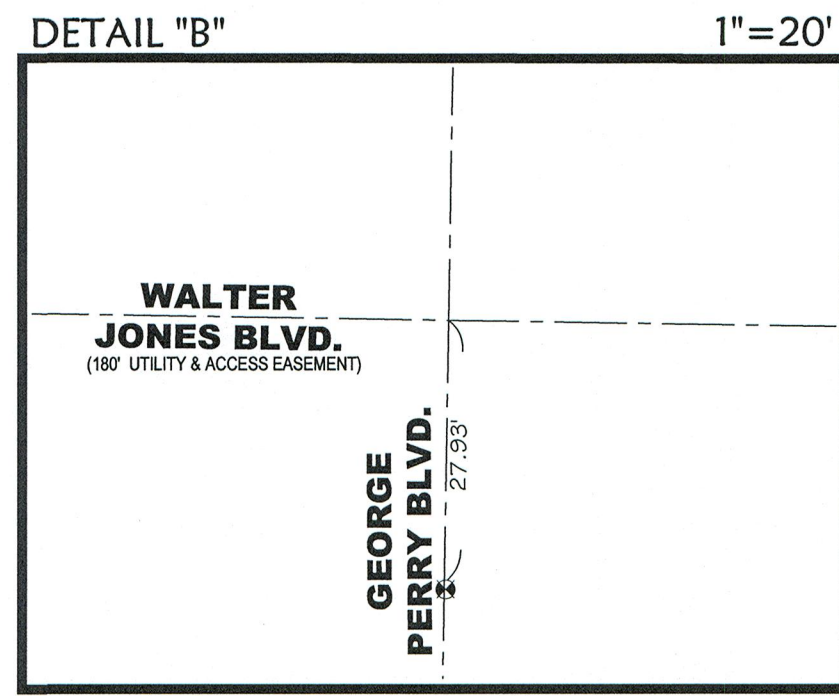
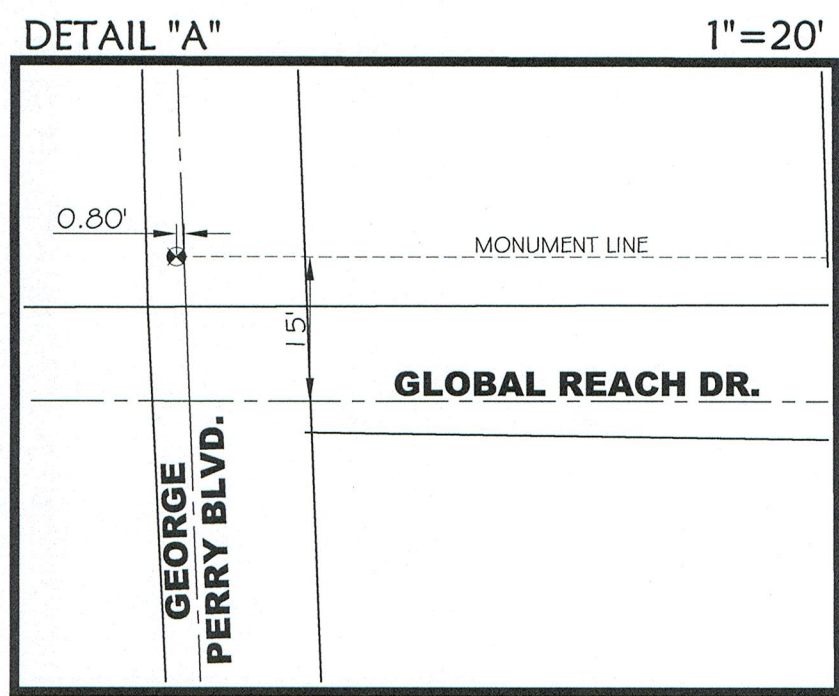
Aaron Alvarado, TX. R. P. L. S. No. 6223

Date: December 23, 2020

05100-106-ROW VACATION-PARCEL 3-DESC.doc

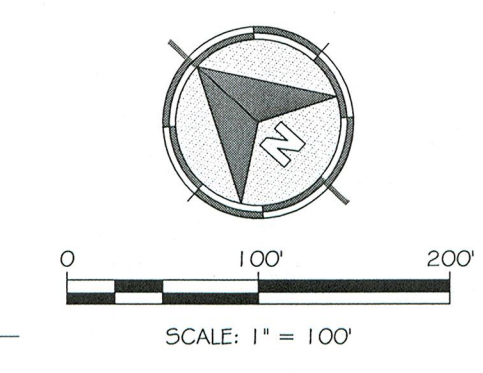
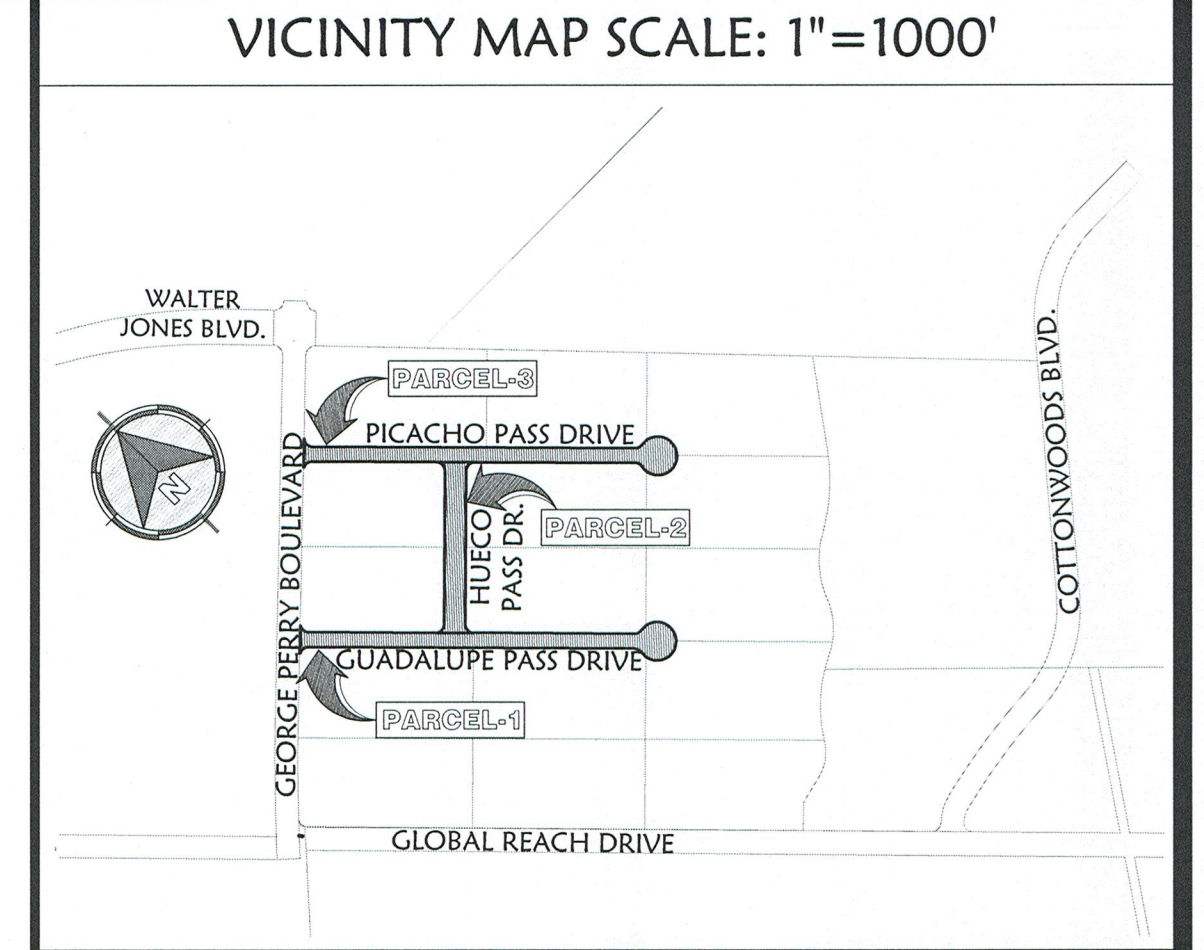


EXHIBIT "B"



CURVE TABLE					
CURVE	RADIUS	DELTA ANGLE	ARC LENGTH	CHORD BEARING	CHORD LENGTH
C1	45.00	90°56'00"	71.42	S00°13'01"W	64.16
C2	45.00	90°00'00"	70.69	N89°45'01"E	63.64
C3	45.00	90°00'00"	70.69	N00°14'59"W	63.64
C4	45.00	89°04'00"	69.95	N89°46'59"W	63.12
C5	45.00	90°56'00"	71.42	S00°13'01"W	64.16
C6	45.00	55°04'53"	43.26	S72°47'25"E	41.61
C7	100.00	290°09'45"	506.43	S44°45'01"W	114.48
C8	45.00	55°04'53"	43.26	N17°42'33"W	41.61
C9	45.00	90°00'00"	70.69	S89°45'01"W	63.64
C10	45.00	90°00'00"	70.69	S00°14'59"E	63.64
C11	45.00	55°04'53"	43.26	S72°47'25"E	41.61
C12	100.00	290°09'45"	506.43	S44°45'01"W	114.48
C13	45.00	55°04'53"	43.26	N17°42'33"W	41.61
C14	45.00	89°04'00"	69.95	N89°46'59"W	63.12
C15	12538.94	3°04'42"	673.68	N44°08'40"E	673.60

LINE TABLE		
LINE #	BEARING	DISTANCE
L1	S45°14'59"E	60.00
L2	N45°41'01"E	83.74
L3	N45°41'01"E	166.02
L4	N45°41'01"E	82.26
L5	S44°18'59"E	60.00



LEGEND	
PROJECT BOUNDARY	---
LOT/RIGHT-OF-WAY LINE	---
CENTERLINE OF RIGHT-OF-WAY	---
EASEMENT LINE	---
MONUMENT LINE	---
SANITARY SEWER LINE	---
STORM SEWER LINE	---
WATER LINE	---
GAS LINE	---
UNDERGROUND ELECTRIC LINE	---
SANITARY SEWER MANHOLE	⊙
STORM SEWER MANHOLE	⊙
LIGHT POLE	⊙
EXISTING DRAINAGE FLOW	→
PROPOSED DRAINAGE FLOW	→
FOUND CITY MONUMENT	⊙
SET 1/2" REBAR WITH SURVEY CAP NO. "TX 6223"	⊙
BLOCK NUMBER	①
EL PASO COUNTY DEED RECORD	E.P.C.D.R.
EL PASO COUNTY PLAT RECORD	E.P.C.P.R.

- SUPPLEMENTAL NOTES**
- BASIS OF BEARING IS BUTTERFIELD TRAIL AVIATION PARK UNIT THREE AS RECORDED IN DOC. NO. 2008008611, PLAT RECORDS, EL PASO COUNTY, TEXAS.
 - SUBJECT PROPERTY IS LOCATED IN ZONE "C" (AREAS OF MINIMAL FLOODING), ZONE "B" (AREAS BETWEEN LIMITS OF THE 100-YEAR FLOOD AND 500-YEAR FLOOD; OR CERTAIN AREAS SUBJECT TO 100-YEAR FLOODING WITH AVERAGE DEPTHS LESS THAN ONE (1) FOOT OR WHERE THE CONTRIBUTING DRAINAGE AREA IS LESS THAN ONE SQUARE MILE; OR AREAS PROTECTED BY LEVEES FROM THE BASE FLOOD) AND ZONE "A-1-4" (AREAS OF 100-YEAR FLOOD; BASE FLOOD ELEVATIONS AND FLOOD HAZARD FACTORS DETERMINED) AS DETAILED ON CITY OF EL PASO, EL PASO COUNTY, TEXAS FLOOD INSURANCE RATE MAP PANEL NO. 490214 0031B, DATED OCTOBER 15, 1982.
 - SUBJECT PROPERTY IS ZONED "C-4" (COMMERCIAL DISTRICT) AS DESIGNATED AT THE CITY OF EL PASO PLANNING DIVISION WEBSITE <http://gis.elpasotexas.gov/planning/>
- REFERENCE DOCUMENTS**
- SUBDIVISION PLAT FOR BUTTERFIELD TRIAL AVIATION UNIT ONE FILED IN BOOK 73, PAGE 50 OF THE EL PASO COUNTY PLAT RECORDS.
 - SUBDIVISION PLAT FOR BUTTERFIELD TRIAL AVIATION UNIT TWO FILED IN DOC. NO. 20030109960 OF THE EL PASO COUNTY PLAT RECORDS.
 - SUBDIVISION PLAT FOR BUTTERFIELD TRIAL AVIATION UNIT THREE FILED IN DOC. NO. 2008008611 OF THE EL PASO COUNTY PLAT RECORDS.

CERTIFICATION

I HEREBY CERTIFY THAT THIS SURVEY PLAT AND THE ACTUAL SURVEY ON THE GROUND UPON WHICH IT IS BASED WERE PERFORMED BY ME OR UNDER MY DIRECT SUPERVISION, THAT I AM RESPONSIBLE FOR THIS SURVEY; THAT THIS SURVEY MEETS THE MINIMUM STANDARDS FOR SURVEYING IN THE STATE OF TEXAS; AND THAT IT IS TRUE AND CORRECT TO THE BEST OF MY KNOWLEDGE AND BELIEF.

Aaron Alvarado 12/23/2020
 AARON ALVARADO, TX, E.P.L.S. NO. 6223

DRAWN BY: C.E.			
APPROVED BY: A.A.			
SCALE: 1"=100'			
DATE: 11-10-2020			
JOB NO. 05100-106			
CREATED PARCEL FOR EACH STREET		DATE: 12/23/2020	SHEET 1 OF 1

BROCK & BUSTILLOS INC.
 CONSULTING CIVIL ENGINEERS
 LAND SURVEYORS
 TBE REG. NO. F-737
 TBE REG. NO. 101314-00

417 EXECUTIVE CENTER
 EL PASO, TEXAS 79902
 www.brockbustillos.com
 PH (915) 542-4300
 FAX (915) 542-2267

Dec 23, 2020 - 3:56pm
 5:\Projects\05100-City of El Paso\106-EPFA TOLLWAY-VACATION.dwg
 allvarado

El Paso International Airport Right-of-Way Vacation



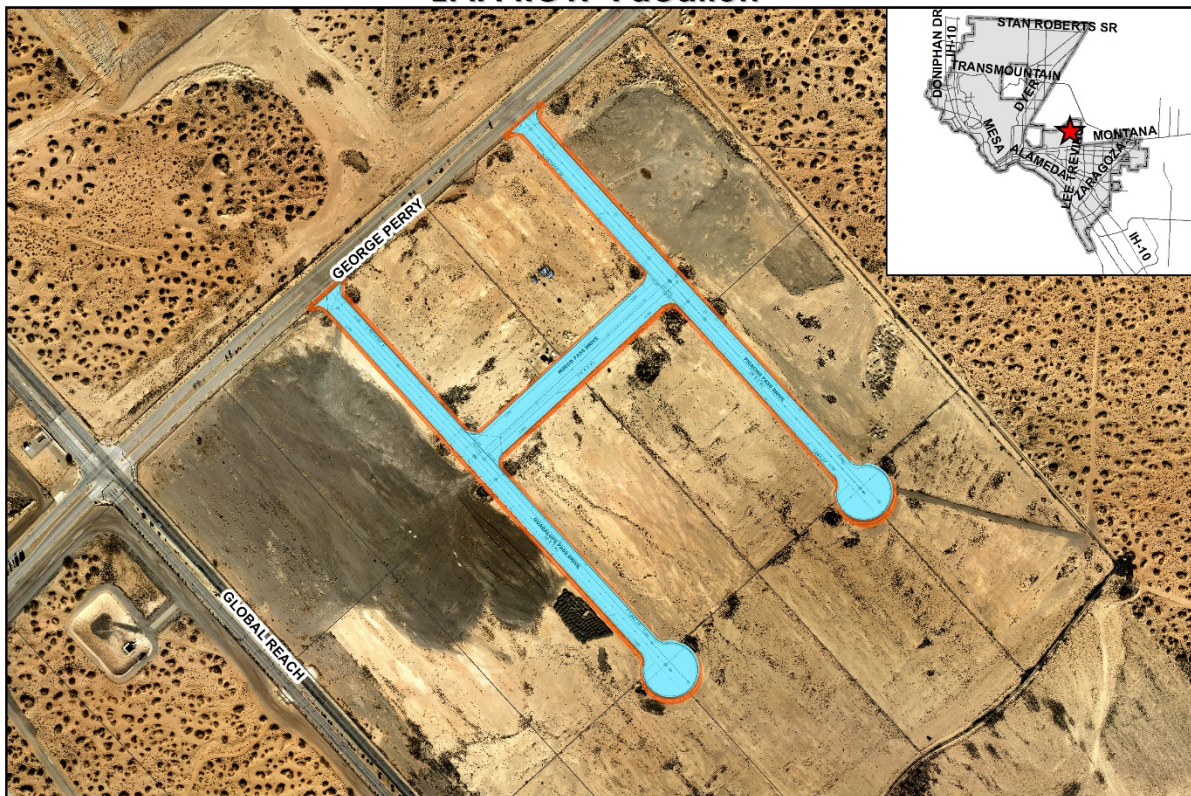
City Plan Commission — February 25, 2021 **REVISED**

CASE NUMBER/TYPE:	SURW21-00001 – RIGHT-OF-WAY VACATION
CASE MANAGER:	Luis Zamora, (915) 212-1552, ZamoraLF@elpasotexas.gov
PROPERTY OWNER:	City of El Paso
REPRESENTATIVE:	Brock & Bustillos, Inc.
LOCATION:	North of Montana Ave. and East of Global Reach Dr. (District 2)
PROPERTY AREA:	9.885 acres
ZONING DISTRICT(S):	C-4 (Commercial)
RELATED APPLICATIONS:	SUSU20-00087 Butterfield Trail Aviation Park Unit Three Replat "A"
PUBLIC INPUT:	No opposition received as of 02/18/2021

SUMMARY OF RECOMMENDATION: Staff recommends **APPROVAL WITH CONDITIONS** of El Paso International Airport Right-of-Way (ROW) Vacation subject to the following condition.

- That the recording of Butterfield Trail Aviation Park Unit Three Replat "A" and the approval of El Paso International Airport Right-of-Way Vacation happen concurrently to avoid landlocking of lots.
- **Prior to City Council, the applicant and utility companies find resolution of existing utility infrastructure located within the subject alley.**

EPIA ROW Vacation



This map is designed for illustrative purposes only. The features depicted here are approximate and more site specific studies may be required to show accurate conclusions. Enlargements of this map to scales greater than its original can introduce errors and may lead to misinterpretations of the data. The Planning & Inspections Department Planning Division makes no claim to its accuracy or completeness.



Subject Property

0 155 310 620 930 1,240 Feet



Figure A: Proposed plat with surrounding area

DESCRIPTION OF REQUEST: The applicant seeks to vacate the existing Picacho Pass Drive, Hueco Pass Drive, and Guadalupe Pass Drive right-of-ways located within Butterfield Trail Aviation Park Unit Three. The subject right-of-ways are paved and have light fixtures. Furthermore, there are El Paso Water mains, which are to be abandoned in place to allow for construction on the site.

CASE HISTORY/RELATED APPLICATIONS: El Paso International Airport Right-of-Way Vacation (SURW21-00001) was approved for a two-week postponement by City Plan Commission on February 11, 2021. Butterfield Trail Aviation Park Unit Three Replat "A" (SUSU20-00087) seeks City Plan Commission (CPC) approval on a resubdivision combination basis.

NEIGHBORHOOD CHARACTER: Surrounding neighborhood characteristics are identified in the following table.

Surrounding Zoning and Use	
North	C-4 (Commercial) / Vacant
South	C-4 (Commercial) / Vacant
East	C-4 (Commercial) / Vacant
West	C-4 (Commercial) / Vacant
Nearest Public Facility and Distance	
Park	Edgemere/Freeport Park Pond (3.16 mi.)
School	Rel Washington Elementary School (3.29 mi.)
Plan El Paso Designation	
G7, Industrial and/or Railyards	
Impact Fee Service Area	
N/A	

PUBLIC COMMENT: Notices of the proposed right-of-way vacation were sent on January 27, 2021 to all property owners within 300 feet of the subject property. As of February 18, 2021, staff has not received any public communication regarding this request.

CITY PLAN COMMISSION OPTIONS:

The City Plan Commission (CPC) has the authority to advise City Council on right-of-way vacation requests. When a request is brought forward to the CPC for review, the Commission may take any of the following actions:

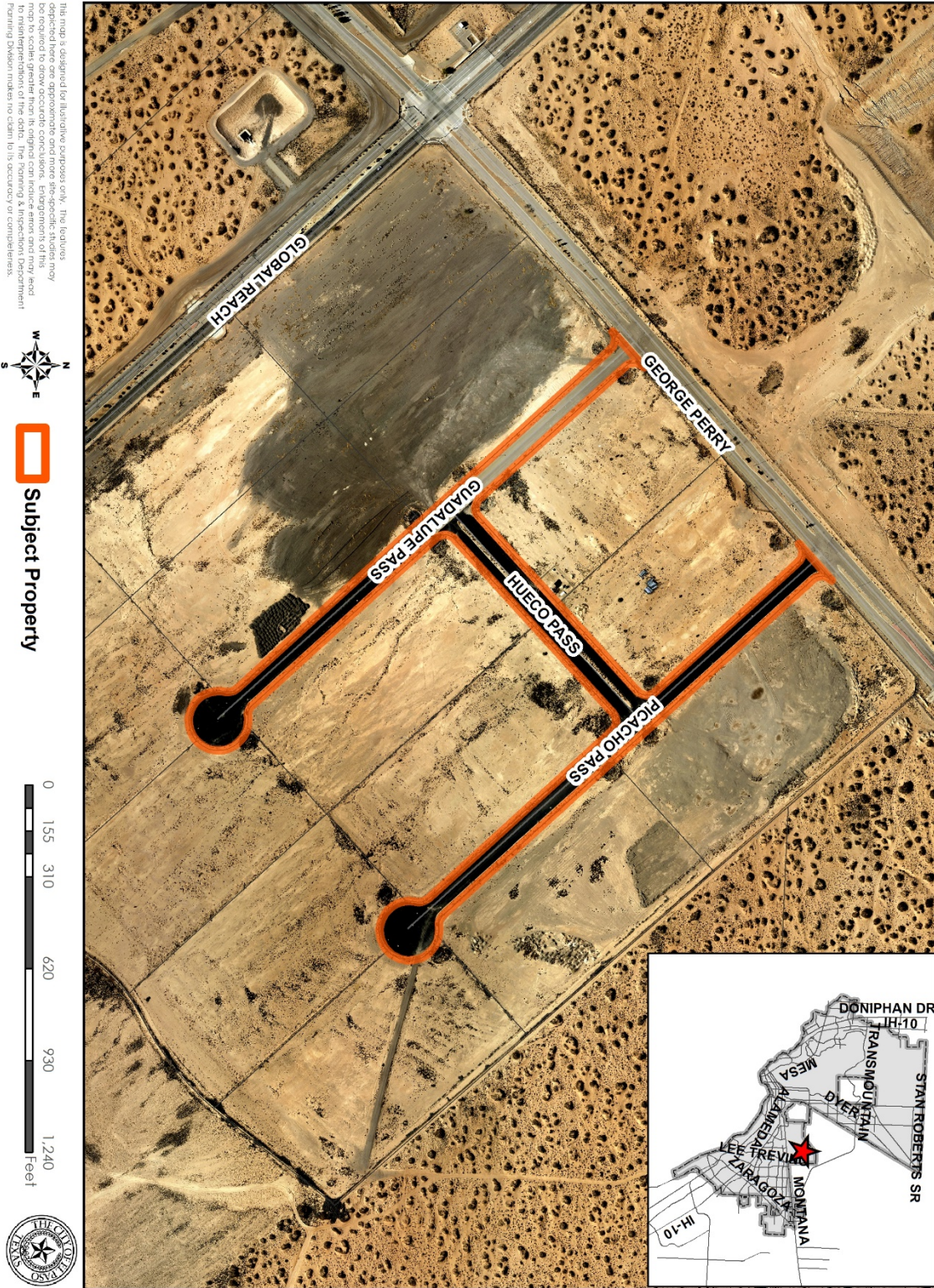
1. **Recommend Approval:** The CPC finds that the proposed vacation request is in conformance with all applicable requirements of Title 19 of the El Paso City Code.
2. **Recommend Approval with Conditions:** The CPC may recommend that City Council impose additional conditions on approval of the request that bring the request into conformance with all applicable requirements of Title 19 of the El Paso City Code. **(Staff Recommendation)**
3. **Recommend Denial:** The CPC finds that the proposed request is not in conformance with all applicable requirements of Title 19 of the El Paso City Code.

ATTACHMENTS:

1. Aerial Map
2. Survey
3. Metes and Bounds Description
4. Application
5. Department Comments

ATTACHMENT 1

EPIA ROW Vacation



This map is designed for illustrative purposes only. The features depicted here are approximate and more site-specific studies may be required to draw accurate conclusions. Enhancements of this map to scales greater than its original can introduce errors and may lead to misinterpretations of the data. The Planning & Inspection Department Planning Division makes no claim to its accuracy or completeness.

ATTACHMENT 3



ROMAN BUSTILLOS, P.E.
President
RANDY P. BROCK, P.E.
Executive Vice President
SERGIO J. ADAME, P.E.
Vice President - Engineering
AARON ALVARADO, R.P.L.S.
Vice President - Surveying
TBPE Reg. No. F-737
TBPLS Reg. No. 101314-00

METES AND BOUNDS DESCRIPTION (GUADALUPE PASS DRIVE) PARCEL 1

A 3.8250 acre parcel situate within the corporate limits of the City of El Paso, El Paso County, Texas as Guadalupe Pass Drive Right-of-Way within Butterfield Trail Aviation Park Unit Three, as recorded in File No. 2008008611, El Paso County Plat Records and being more particularly described by metes and bounds as follows:

COMMENCING for reference at a city monument found at the centerline intersection of George Perry Boulevard (120 feet wide) and the right-of-way centerline of Guadalupe Pass Drive (76 feet wide); **WHENCE**, a city monument found along the centerline of said George Perry Boulevard and 27.9 feet west of the centerline of Walter Jones Boulevard (180 feet wide) bears, North 45°41'01" East, a distance of 1,577.90 feet; **THENCE**, leaving the centerline of said George Perry Boulevard and following the centerline of said Guadalupe Pass Drive, South 45°14'59" East, a distance of 60.00 feet to the **POINT OF BEGINNING** of the parcel herein described;

THENCE, North 45°41'01" East, a distance of 83.74 feet to the beginning of a non-tangent curve to the left;

THENCE, along the arc of said non-tangent curve to the left having a radius of 45.00 feet, a central angle of 90°56'00", an arc length of 71.42 feet and whose long chord bears South 00°13'01" West, a distance of 64.16 feet to a point of tangency;

THENCE, South 45°14'59" East, a distance of 1,697.15 feet to a point of curvature;

THENCE, along the arc of a curve to the left having a radius of 45.00 feet, a central angle of 55°04'53", an arc length of 43.26 feet and whose long chord bears South 72°47'25" East, a distance of 41.61 feet to a point of reverse curvature;

THENCE, along the arc of a curve to the right having a radius of 100.00 feet, a central angle of 290°09'45", an arc length of 506.43 feet and whose long chord bears South 44°45'01" West, a distance of 114.48 feet to a point of reverse curvature;

THENCE, along the arc of a curve to the left having a radius of 45.00 feet, a central angle of 55°04'53", an arc length of 43.26 feet and whose long chord bears North 17°42'33" West, a distance of 41.61 feet to a point of tangency;

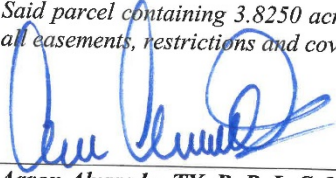
THENCE, North 45°14'59" West, a distance of 1,699.85 feet to a point of curvature;

THENCE, along the arc of a curve to the left having a radius of 45.00 feet, a central angle of 89°04'00", an arc length of 69.95 feet and whose long chord bears North 89°46'59" West, a distance of 63.12 feet to the end of said curve;

417 Executive Center Blvd. • El Paso, Texas 79902 • P - (915) 542-4900 • F - (915) 542-2867 • www.brockbustillos.com

THENCE, North 45°41'01" East, a distance of 82.28 feet to the **POINT OF BEGINNING**.

Said parcel containing 3.8250 acres (166,619.1 square feet), more or less, and being subject to all easements, restrictions and covenants of record.



Aaron Alvarado, TX. R. P. L. S. No. 6223

Date: December 23, 2020

05100-106-ROW VACATION-PARCEL 1-DESC.doc





ROMAN BUSTILLOS, P.E.
President
RANDY P. BROCK, P.E.
Executive Vice President
SERGIO J. ADAME, P.E.
Vice President - Engineering
AARON ALVARADO, R.P.L.S.
Vice President - Surveying
TBPE Reg. No. F-737
TBPLS Reg. No. 101314-00

METES AND BOUNDS DESCRIPTION
(HUECO PASS DRIVE)
PARCEL-2

A 2.2621 acre parcel situate within the corporate limits of the City of El Paso, El Paso County, Texas as Hueco Pass Drive Right-of-Way within Butterfield Trail Aviation Park Unit Three, as recorded in File No. 2008008611, El Paso County Plat Records and being more particularly described by metes and bounds as follows:

COMMENCING for reference at a city monument found at the centerline intersection of George Perry Boulevard (120 feet wide) and the right-of-way centerline of Guadalupe Pass Drive (76 feet wide); **WHENCE**, a city monument found along the centerline of said George Perry Boulevard and 27.9 feet west of the centerline of Walter Jones Boulevard (180 feet wide) bears, North 45°41'01" East, a distance of 1,577.90 feet; **THENCE**, leaving the centerline of said George Perry Boulevard and following the centerline of said Guadalupe Pass Drive, South 45°14'59" East, a distance of 60.00 feet; **THENCE**, North 45°41'01" East, a distance of 83.74 feet to the beginning of a non-tangent curve to the left; **THENCE**, along the arc of said non-tangent curve to the left having a radius of 45.00 feet, a central angle of 90°56'00", an arc length of 71.42 feet and whose long chord bears South 00°13'01" West, a distance of 64.16 feet to a point of tangency; **THENCE**, South 45°14'59" East, a distance of 660.51 feet to a point of curvature and the **POINT OF BEGINNING** of the parcel herein described;

THENCE, along the arc of a curve to the left having a radius of 45.00 feet, a central angle of 90°00'00", an arc length of 70.69 feet and whose long chord bears North 89°45'01" East, a distance of 63.64 feet to a point of tangency;

THENCE, North 44°45'01" East, a distance of 790.00 feet to a point of curvature;

THENCE, along the arc of a curve to the left having a radius of 45.00 feet, a central angle of 90°00'00", an arc length of 70.69 feet and whose long chord bears North 00°14'59" West, a distance of 63.64 feet to the end of said curve;

THENCE, South 45°14'59" East, a distance of 200.00 feet to the beginning of a non-tangent curve to the left;

THENCE, along the arc of said non-tangent curve to the left having a radius of 45.00 feet, a central angle of 90°00'00", an arc length of 70.69 feet and whose long chord bears South 89°45'01" West, a distance of 63.64 feet to a point of tangency;

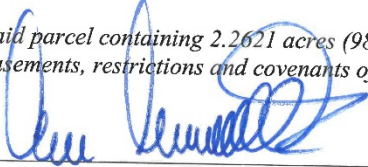
THENCE, South 44°45'01" West, a distance of 790.00 feet a point of curvature;

THENCE, along the arc of a curve to the left having a radius of 45.00 feet, a central angle of 90°00'00", an arc length of 70.69 feet and whose long chord bears South 00°14'59" East, a distance of 63.64 feet to the end of said curve;

417 Executive Center Blvd. • El Paso, Texas 79902 • P - (915) 542-4900 • F - (915) 542-2867 • www.brockbustillos.com

THENCE, North 45°14'59" West, a distance of 200.00 feet to the **POINT OF BEGINNING**.

Said parcel containing 2.2621 acres (98,538.3 square feet), more or less, and being subject to all easements, restrictions and covenants of record.



Aaron Alvarado, TX. R. P. L. S. No. 6223

Date: December 23, 2020

05100-106-ROW VACATION-PARCEL 2-DESC.doc





ROMAN BUSTILLOS, P.E.
President
RANDY P. BROCK, P.E.
Executive Vice President
SERGIO J. ADAME, P.E.
Vice President - Engineering
AARON ALVARADO, R.P.L.S.
Vice President - Surveying
TBPE Reg. No. F-737
TBPLS Reg. No. 101314-00

METES AND BOUNDS DESCRIPTION
(PICACHO PASS DRIVE)
PARCEL-3

A 3.7979 acre parcel situate within the corporate limits of the City of El Paso, El Paso County, Texas as Picacho Pass Drive Right-of-Way within Butterfield Trail Aviation Park Unit Three, as recorded in File No. 2008008611, El Paso County Plat Records and being more particularly described by metes and bounds as follows:

COMMENCING for reference at a city monument found at the centerline intersection of George Perry Boulevard (120 feet wide) and the right-of-way centerline of Guadalupe Pass Drive (76 feet wide); **WHENCE**, a city monument found along the centerline of said George Perry Boulevard and 27.9 feet west of the centerline of Walter Jones Boulevard (180 feet wide) bears, North 45°41'01" East, a distance of 1,577.90 feet; **THENCE**, following the centerline of said George Perry Boulevard, North 45°41'01" East, a distance of 874.83 feet; **THENCE**, leaving the centerline of said George Perry Boulevard, South 44°18'59" East, a distance of 60.00 feet to the **POINT OF BEGINNING** of the parcel herein described;

THENCE, North 45°41'01" East, a distance of 166.02 feet to the beginning of a non-tangent curve to the left;

THENCE, along the arc of said non-tangent curve to the left having a radius of 45.00 feet, a central angle of 90°56'00", an arc length of 71.42 feet and whose long chord bears South 00°13'01" West, a distance of 64.16 feet to a point of tangency;

THENCE, South 45°14'59" East, a distance of 1,681.57 feet to a point of curvature;

THENCE, along the arc of a curve to the left having a radius of 45.00 feet, a central angle of 55°04'53", an arc length of 43.26 feet and whose long chord bears South 72°47'25" East, a distance of 41.61 feet to a point of reverse curvature;

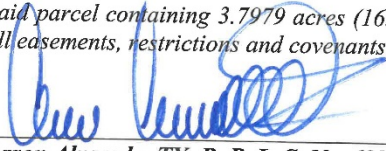
THENCE, along the arc of a curve to the right having a radius of 100.00 feet, a central angle of 290°09'45", an arc length of 506.43 feet and whose long chord bears South 44°45'01" West, a distance of 114.48 feet to a point of reverse curvature;

THENCE, along the arc of a curve to the left having a radius of 45.00 feet, a central angle of 55°04'53", an arc length of 43.26 feet and whose long chord bears North 17°42'33" West, a distance of 41.61 feet to a point of tangency;

THENCE, North 45°14'59" West, a distance of 1,684.27 feet to a point of curvature;

THENCE, along the arc of a curve to the left having a radius of 45.00 feet, a central angle of 90°00'00", an arc length of 70.69 feet and whose long chord bears South 89°45'01" West, a distance of 63.64 feet to the **POINT OF BEGINNING**.

Said parcel containing 3.7979 acres (165,435.2 square feet), more or less, and being subject to all easements, restrictions and covenants of record.



Aaron Alvarado, TX. R. P. L. S. No. 6223

Date: December 23, 2020

05100-106-ROW VACATION-PARCEL 3-DESC.doc



ATTACHMENT 4



VACATION PUBLIC EASEMENTS AND RIGHTS-OF-WAY APPLICATION

Date: December 4, 2020 File No. SURW21-00001

1. APPLICANTS NAME City of El Paso (EPIA)
 ADDRESS 300 N. Campbell ZIP CODE 79901 TELEPHONE 915-212-0000
2. Request is hereby made to vacate the following: (check one)
 Street Alley Easement Other
 Street Name(s) Picacho Pass Dr, Hueco Pass Dr, Guadalupe Pass Dr Subdivision Name Butterfield Trail Aviation Park Unit 3
 Abutting Blocks 2 & 3 Abutting Lots 1 & 2; 6 - 15
3. Reason for vacation request: Re-platting all unit 3 into one lot and need to remove all improved streets.
4. Surface Improvements located in subject property to be vacated:
 None Paving Curb & Gutter Power Lines/Poles Fences/Walls Structures Other
5. Underground Improvements located in the existing rights-of-way:
 None Telephone Electric Gas Water Sewer Storm Drain Other
6. Future use of the vacated right-of-way:
 Yards Parking Expand Building Area Replat with abutting Land Other
7. Related Applications which are pending (give name or file number): SUFR20-00152
 Zoning Board of Adjustment Subdivision Building Permits Other
8. Signatures: All owners of properties which abut the property to be vacated must appear below with an adequate legal description of the properties they own (use additional paper if necessary).

Signature	Legal Description	Telephone
<u>City of El Paso</u>	<u>All of Butterfield Trail Aviation Park Unit 3</u>	<u>915-212-7337</u>

The undersigned Owner/Applicant/Agent understands that the processing of this Application will be handled in accordance with the procedure for Requesting Vacations and that no action on processing will be taken without payment of the non-refundable processing fee. It is further understood that acceptance of this application and fee in no way obligates the City to grant the Vacation. I/We further understand that the fee, if the Vacation is granted will be determined by the City of El Paso and a Certified or Cashier's Check must be presented before the request will be recommended for Council action.

The undersigned acknowledges that he or she is authorized to do so, and upon the City's request will provide evidence satisfactory to the City confirming these representations.

The granting of a vacation request shall not be construed to be a waiver of or an approval of any violation of any of the provisions of any applicable City ordinances.

OWNER SIGNATURE: [Signature] REPRESENTATIVE SIGNATURE: [Signature]

REPRESENTATIVE (PHONE): 915-542-4900 ext. 36

REPRESENTATIVE (E-MAIL): aaron@brockbusillos.com

NOTE: SUBMITTAL OF AN APPLICATION DOES NOT CONSTITUTE ACCEPTANCE FOR PROCESSING UNTIL THE PLANNING DEPARTMENT REVIEWS THE APPLICATION FOR ACCURACY AND COMPLETENESS.

Planning & Inspections Department
 811 Texas | P.O. Box 1890 | El Paso, Texas 79950-1890 | (915) 212-0085

ATTACHMENT 5

Planning and Inspections Department- Planning Division

1. The recording of Butterfield Trail Aviation Park Unit Three Replat "A" and the approval of El Paso International Airport Right-of-Way Vacation to happen concurrently to avoid landlocking of lots.
2. Prior to City Council, the applicant and utility companies find resolution of existing utility infrastructure located within the subject alley

Planning and Inspections Department- Land Development Division

No objections to ROW vacation.

Parks and Recreation:

We have reviewed **EPIA ROW Vacation** survey map and on behalf of Parks & Recreation Department we offer "No" objections to this proposed Street Right-of-way vacation request.

Sun Metro:

No adverse comments.

Fire Department:

No objections.

Streets and Maintenance Department:

No objections.

Capital Improvement Department

No comments received.

El Paso Water Utilities:

EPWater does not objects to this request.

The mains are to be abandoned in place. The Developer's is responsible for all costs associated with the abandonment of these mains.

Water:

There is an existing 12-inch and 8-inch diameter water main that extends along the southside of Guadalupe Pass Drive.

There is an existing 12-inch and 8-inch diameter water main that extends along the south side of Picacho Pass Drive.

There is an existing 12-inch diameter water main that extends along the east side of Hueco Pass Drive.

Previous water pressure readings from fire hydrant #8258 located on George Perry Blvd. approximately 1,789-feet east of Global Reach Blvd., have yielded a static pressure of 82 psi, a residual pressure of 60 psi, and a discharge flow of 1,061 gallons per minute. The owner should, for his own protection and at his own expense, install at the discharge side of each water meter a pressure regulator, strainer and relief

valve, to be set for pressure as desired by the customer. The lot owner shall be responsible for the operation and maintenance of the above-described water pressure regulating device.

Sanitary Sewer:

There is an existing 8-inch diameter sewer main that extends along the north side of Guadalupe Pass Drive.

There is an existing 8-inch diameter sewer main that extends along the north side of Picacho Pass Drive.

There is an existing 8-inch diameter sewer main that extends along the south side of Hueco Pass Drive.

General:

EPWater requires a new service application to provide additional service to the property. New service applications are available at 1154 Hawkins, 3rd floor and should be made 6 to 8 weeks in advance of construction to ensure water for construction work. A site plan, utility plan, grading and drainage plans, landscaping plan, the legal description of the property and a certificate-of-compliance are required at the time of application. Service will be provided in accordance with the current EPWater – PSB Rules and Regulations. The applicant is responsible for the costs of any necessary on-site and off-site extensions, relocations or adjustments of water and sanitary sewer lines and appurtenances.

Texas Gas

No comments received.

El Paso Electric

1. A utility easement along the Guadalupe Pass Drive and Hueco Pass Drive will remain in favor of El Paso Electric Company and their successors and assigns for the infrastructure in existence in the roadway on the date of this vacating ordinance. The rights granted by this utility easement include rights of access, operation, inspection, repair, replacement with like-kind infrastructure, removal, and maintenance by El Paso Electric Company and their successors and assigns.
2. The applicant will need to coordinate with EPE Engineering Department to request removal or relocation of existing facilities
3. Future land rights shall be granted by separate instrument.

Spectrum:

We have reviewed your request for the above referenced locations, and Spectrum Communications hereby states there are no objections with the proposed ROW vacation within the limits of Picacho Pass, Hueco Pass & Guadalupe Pass, El Paso, TX. Spectrum Communications retains the right of access to any remaining partial or full utility easements on the property for the purpose of future construction or maintenance of existing facilities.

El Paso County 911 District

No comments received.

Texas Department of Transportation

Proposed development is not abutting TxDOT right of way.

El Paso County

No comments received.

El Paso County Water Improvement District #1

Not within the boundaries of EPCWID.