

**CITY OF EL PASO, TEXAS
AGENDA ITEM
DEPARTMENT HEAD'S SUMMARY FORM**

AGENDA DATE: September 13, 2022

PUBLIC HEARING DATE: N/A

CONTACT PERSON: Samuel Rodriguez, P.E., Aviation Director, (915) 212-7301

DISTRICT(S) AFFECTED: 3

STRATEGIC GOAL 1: Create an Environment Conducive to Strong, Sustainable Economic Development

SUBGOAL: N/A

SUBJECT:

That the City Manager be authorized to sign Lease No. HSBP-7421-L-DA1203, on behalf of the City of El Paso ("Lessor"), with the United States Customs and Border Protection ("Lessee"), for the lease of Aviation Hangar Building No. 806, with contiguous office/support space, in addition to access to and use of all common areas located on the premises or associated with the leased space, including adjoining apron/ramp space and certain parking spaces located at the following described property:

A portion of Lot 2, Block 4, El Paso International Airport Tracts Unit Ten (3.4186 acres parcel), City of El Paso, El Paso County, Texas, municipally known and numbered as 1820 American Drive, El Paso, Texas,

and that the Director of Aviation or successor be authorized to execute an amendment to the lease to identify the metes and bounds description and applicable square footage for the aircraft parking ramp and the parking lot once the survey for same is/are finalized.

The fifteen-year (15) year initial term begins on September 13, 2022 ("Effective Date") and ends on September 12, 2037. The annual rental fee is \$328,365.98 or \$27,363.83 per month, which includes reimbursement for tenant improvements. There is one (1) option to extend the lease for an additional five (5) years that can be exercised by the Government with a 120-day notice to the Lessor. Should the five (5) year option be exercised the end date will be September 12, 2042, and the annual rental fee will be \$183,057.28 or \$15,254.77 per month.

BACKGROUND / DISCUSSION:

The Lessee currently leases an adjacent hangar located at 6812 Northrup Road, which is used to maintain and operate aircraft used to further CBP's mission to "protect the American people, safeguard our borders, and enhance the nation's economic prosperity." CBP's mission in the El Paso Sector has grown over the years. As such, CBP has outgrown its current space and requires more space to house and maintain aircraft and personnel needed to accomplish their mission objectives.

Please note that the agreement provided for approval is for the lease of the building and 1.76 acres of the property as the metes and bounds for this property missed the eastern portion of the ramp and parking lot. ELP engaged the surveyor to revise the survey to encompass the 3.4186 acres to be leased. CBP will issue an amendment to the agreement to include the additional space and ELP requests that the Director of Aviation be authorized to sign this amendment.

PRIOR COUNCIL ACTION:

N/A

AMOUNT AND SOURCE OF FUNDING:

Revised 04/09/2021

N/A: This is a revenue-generating item.

HAVE ALL AFFECTED DEPARTMENTS BEEN NOTIFIED? YES NO

PRIMARY DEPARTMENT: Aviation
SECONDARY DEPARTMENT: N/A

*****REQUIRED AUTHORIZATION*****

DEPARTMENT HEAD: 

Samuel Rodriguez, P.E., Director of Aviation

RESOLUTION

WHEREAS, the City of El Paso owns and operates the El Paso International Airport as depicted in the most current FAA approved Airport Layout Plan located in the County of El Paso, State of Texas; and

WHEREAS, the United States Customs and Border Protection would like to lease property to operate a facility at the El Paso International Airport; and

WHEREAS, the City of El Paso desires to lease to the United States Customs and Border Protection certain facilities located at the El Paso International Airport in accordance with the terms, covenants, and conditions set forth in the lease including a delegation of authority to the Lessor's Director of Aviation or his successor to execute amendments to the lease to identify the metes and bounds descriptions and applicable square footage for the aircraft parking ramp and the parking lot as the survey for same is finalized.

BE IT RESOLVED BY THE CITY COUNCIL OF THE CITY OF EL PASO:

THAT the City Manager be authorized to sign Lease No. HSBP-7421-L-DA1203, on behalf of the City of El Paso ("Lessor"), with the United States Customs and Border Protection ("Lessee"), for the lease of Aviation Hangar Building No. 806, with contiguous office/support space, in addition to access to and use of all common areas located on the premises or associated with the leased space, including adjoining apron/ramp space and certain parking spaces located at the following described property:

A portion of Lot 2, Block 4, El Paso International Airport Tracts Unit Ten (3.4186 acres parcel). City of El Paso, El Paso County, Texas, municipally known and numbered as 1820 American Drive, El Paso, Texas.

and that the Director of Aviation or successor be authorized to execute an amendment to the lease to identify the metes and bounds description and applicable square footage for the aircraft parking ramp and the parking lot once the survey for same is/are finalized.

(Signatures appear on following page)

Dated this ____ day of _____, 2022.

CITY OF EL PASO

Oscar Leaser
Mayor

ATTEST:

Laura D. Prine
City Clerk

APPROVED AS TO FORM:



Josette Flores
Senior Assistant City Attorney

APPROVED AS TO CONTENT:



Samuel Rodriguez, P.E.
Director of Aviation

RESOLUTION

21-1003-1192/PL#1119054 2 USC BP - 1820 American - RESO/JF

In Witness Whereof, the parties to this Lease evidence their agreement to all terms and conditions set forth herein by their signatures below, to be effective as of the date of delivery of the fully executed Lease to the Lessor.

FOR THE LESSOR:

Name: Tomas Gonzalez
Title: City Manager
Entity: City of El Paso
Date: _____

FOR THE GOVERNMENT:

Name: Chatigny L. Davis
Title: Lease Contracting Officer
Entity: Department of Homeland Security, U.S. Customs and Border Protection
Date: _____

APPROVED AS TO FORM:



Name: Josette Flores
Title: Senior Assistant City Attorney
Entity: City of El Paso
Date: 9-6-22

APPROVED AS TO CONTENT:



Name: Samuel Rodriguez, PE
Title: Director of Aviation
Entity: City of El Paso
Date: 9-6-2022

WITNESSED FOR THE LESSOR BY:

Name: _____
Title: _____
Date: _____

A. This Lease is made and entered into between

City of El Paso

(Lessor), whose principal place of business is **El Paso International Airport, 6701 Convair Road, El Paso, TX 79925**, and whose interest in the Property described herein is that of Fee Owner, and

The United States of America

(Government), acting by and through the designated representative of the U.S. Customs and Border Protection (CBP), upon the terms and conditions set forth herein.

B. Witnesseth: The parties hereto, for the consideration hereinafter mentioned, covenant and agree as follows:

Lessor hereby leases to the Government the Premises described herein, being all or a portion of the Property located at

El Paso International Airport, 1820 American Drive, El Paso, TX, 79925

and more fully described in Section 1 and Exhibit B, together with rights to the use of parking and other areas as set forth herein, to be used for such purposes as determined by CBP.

C. LEASE TERM

To Have and To Hold the said Premises with its appurtenances for the term beginning upon acceptance of the Premises as required by this Lease and continuing for a period of

Twenty (20) Years, Fifteen (15) Years Firm,

subject to adequate funds being made available from Congress for the payment of rentals under this Lease and termination and renewal rights as may be hereinafter set forth. The commencement date of this Lease, along with any applicable termination and renewal rights, shall be more specifically set forth in a Lease Amendment upon substantial completion and acceptance of the Space by the Government.

The information collection requirements contained in this Solicitation/Contract, that are not required by regulation, have been approved by the Office of Management and Budget pursuant to the Paperwork Reduction Act and assigned the OMB Control No. 3090-0163.

In Witness Whereof, the parties to this Lease evidence their agreement to all terms and conditions set forth herein by their signatures below, to be effective as of the date of delivery of the fully executed Lease to the Lessor.

FOR THE LESSOR:

Name: Tomas Gonzalez
Title: City Manager
Entity: City of El Paso
Date: _____

FOR THE GOVERNMENT:

Name: Chatigny L. Davis
Title: Lease Contracting Officer
Entity: Department of Homeland Security, U.S. Customs and Border Protection
Date: _____

APPROVED AS TO FORM:

J. Flores

Name: Josette Flores
Title: Senior Assistant City Attorney
Entity: City of El Paso
Date: 9-6-22

APPROVED AS TO CONTENT:

Samuel Rodriguez

Name: Samuel Rodriguez, PE
Title: Director of Aviation
Entity: City of El Paso
Date: 9-6-2022

WITNESSED FOR THE LESSOR BY:

Name: _____
Title: _____
Date: _____

SECTION 1 THE PREMISES, RENT, AND OTHER TERMS	5
1.01 THE PREMISES (SEP 2015).....	5
1.02 EXPRESS APPURTENANT RIGHTS (SEP 2013).....	5
1.03 RENT AND OTHER CONSIDERATION (ON-AIRPORT) (OCT 2021).....	5
1.04 TERMINATION RIGHTS (ON-AIRPORT) (SEP 2013).....	6
1.05 RENEWAL RIGHTS (OCT 2016) INTENTIONALLY DELETED.....	6
1.06 DOCUMENTS INCORPORATED IN THE LEASE (ON-AIRPORT) (OCT 2020).....	7
1.07 OPERATING COST BASE (OCT 2016).....	7
1.08 LESSOR'S UNIQUE ENTITY IDENTIFIER (OCT 2021).....	7
SECTION 2 GENERAL TERMS, CONDITIONS, AND STANDARDS	8
2.01 DEFINITIONS AND GENERAL TERMS (OCT 2016).....	8
2.02 AUTHORIZED REPRESENTATIVES (OCT 2016).....	8
2.03 ALTERATIONS REQUESTED BY THE GOVERNMENT (OCT 2018).....	9
2.04 WAIVER OF RESTORATION (OCT 2021).....	9
2.05 OPERATING COSTS ADJUSTMENT (JUN 2012) INTENTIONALLY DELETED.....	9
2.06 CHANGE OF OWNERSHIP/NOVATION (OCT 2021).....	9
2.07 RELOCATION RIGHTS (OCT 2021) INTENTIONALLY DELETED.....	9
2.08 RECITALS FOR TRANSPORTATION SECURITY ADMINISTRATION (ON-AIRPORT) (JUN 2012) INTENTIONALLY DELETED.....	9
2.09 ACCEPTANCE OF SPACE AND CERTIFICATE OF OCCUPANCY (ON-AIRPORT) (MAY 2015).....	10
2.10 ALTERATIONS PRIOR TO ACCEPTANCE (JUN 2012).....	10
2.11 SYSTEM FOR AWARD MANAGEMENT (MAR 2020).....	10
2.12 SECURITY UPGRADES DUE TO IMMEDIATE THREAT (APR 2011).....	10
SECTION 3 CONSTRUCTION STANDARDS AND SHELL COMPONENTS	11
3.01 BUILDING SHELL REQUIREMENTS (ON-AIRPORT) (SEP 2013).....	11
3.02 MEANS OF EGRESS (MAY 2015).....	11
3.03 AUTOMATIC FIRE SPRINKLER SYSTEM (SEP 2013).....	11
3.04 FIRE ALARM SYSTEM (SEP 2013).....	11
3.05 ENERGY INDEPENDENCE AND SECURITY ACT (DEC 2014) INTENTIONALLY DELETED.....	11
3.06 ACCESSIBILITY (FEB 2007).....	12
3.07 MECHANICAL, ELECTRICAL, PLUMBING: GENERAL (APR 2011).....	12
3.08 RESTROOMS (ON-AIRPORT) (JUN 2012) INTENTIONALLY DELETED.....	12
3.09 HEATING, VENTILATION, AND AIR CONDITIONING (ON-AIRPORT) (APR 2011).....	12
3.10 TELECOMMUNICATIONS: LOCAL EXCHANGE ACCESS (ON-AIRPORT) (SEP 2013).....	12
3.11 GOVERNMENT PROJECT MANAGEMENT SYSTEM (ON-AIRPORT) (OCT 2021).....	12
SECTION 4 UTILITIES, SERVICES, AND OBLIGATIONS DURING THE LEASE TERM	13
4.01 SERVICES, UTILITIES, AND MAINTENANCE (ON-AIRPORT) (OCT 2020).....	13
4.02 PROVISION OF SERVICES, ACCESS, AND NORMAL HOURS FOR AIRPORT OCCUPANCIES (SEP 2013).....	13
4.03 MAINTENANCE AND TESTING OF SYSTEMS (SEP 2013) INTENTIONALLY DELETED.....	13
4.04 RECYCLING (ON-AIRPORT) (JUN 2012).....	13
4.05 RANDOLPH-SHEPPARD COMPLIANCE (SEP 2013).....	13
4.06 SAFEGUARDING AND DISSEMINATION OF CONTROLLED UNCLASSIFIED INFORMATION (CUI) BUILDING INFORMATION (FEB 2020).....	13
4.07 INDOOR AIR QUALITY (OCT 2019).....	14
4.08 HAZARDOUS MATERIALS (ON-AIRPORT) (OCT 2021).....	15
4.09 OCCUPANT EMERGENCY PLANS (OCT 2020).....	15
SECTION 5 ADDITIONAL TERMS AND CONDITIONS	16
5.01 PROVISIONAL ACCEPTANCE (FEB 2021).....	16
5.02 TENANT IMPROVEMENT RENTAL ADJUSTMENT (OCT 2016).....	16
5.03 QUALITY AND APPEARANCE OF BUILDING (JUN 2012).....	16
5.04 DEMOLITION (JUN 2012).....	16
5.05 FLOOR COVERING AND PERIMETERS – SHELL (SLAT) (OCT 2020).....	16
5.06 ELECTRICAL (SLAT) (OCT 2020).....	16
5.07 ADDITIONAL ELECTRICAL CONTROLS (JUN 2012).....	16
5.08 DRINKING FOUNTAINS (OCT 2018).....	17
5.09 LIGHTING: INTERIOR AND PARKING – SHELL (SLAT) (OCT 2020).....	17
5.10 WORK PERFORMANCE (JUN 2012).....	17
5.11 SCHEDULE FOR COMPLETION OF SPACE (OCT 2020).....	17
5.12 CONSTRUCTION DOCUMENTS (SEP 2012).....	18
5.13 RESPONSIBILITY OF THE LESSOR AND LESSOR'S ARCHITECT/ENGINEER (JUN 2012).....	18
5.14 CONSTRUCTION SCHEDULE AND INITIAL CONSTRUCTION MEETING (OCT 2020).....	18
5.15 PROGRESS REPORTS (OCT 2020).....	18
5.16 CONSTRUCTION INSPECTIONS (SEP 2015).....	18
5.17 ACCESS BY THE GOVERNMENT PRIOR TO ACCEPTANCE (SEP 2013).....	19
5.18 ACCEPTANCE OF SPACE AND CERTIFICATE OF OCCUPANCY (OCT 2021).....	19

5.19	LEASE TERM COMMENCEMENT DATE AND RENT RECONCILIATION (OCT 2021).....	19
5.20	AS-BUILT DRAWINGS (OCT 2021).....	19
5.21	LESSOR'S PROJECT MANAGEMENT RESPONSIBILITIES (OCT 2020).....	19
5.22	TENANT IMPROVEMENT REQUIREMENTS (OCT 2016).....	20
5.23	FINISH SELECTIONS (SMALL) (SEP 2015).....	20
5.24	WINDOW COVERINGS (SMALL) (OCT 2020).....	20
5.25	DOORS: INTERIOR (SLAT) (OCT 2020).....	20
5.26	DOORS: HARDWARE (SEP 2013).....	20
5.27	DOORS: IDENTIFICATION (JUN 2012).....	20
5.28	PARTITIONS: SUBDIVIDING (SLAT) (OCT 2020) INTENTIONALLY DELETED	20
5.29	PAINTING – TI (SMALL) (OCT 2020).....	20
5.30	FLOOR COVERINGS AND PERIMETERS (SMALL) (OCT 2019).....	20
5.31	TELECOMMUNICATIONS: DISTRIBUTION AND EQUIPMENT (JUN 2012).....	20
5.32	DATA DISTRIBUTION (OCT 2020).....	21
5.33	ELECTRICAL, TELEPHONE, DATA FOR SYSTEMS FURNITURE (OCT 2020).....	21
5.34	SECURITY REQUIREMENTS (OCT 2021).....	21
5.35	OWNERSHIP.....	21
5.36	NO WAIVER OF SOVEREIGN IMMUNITY.....	21
5.37	LEASE EXPIRATION.....	Error! Bookmark not defined.
5.38	NO THIRD PARTY BENEFICIARY.....	21
5.39	FAA PROVISIONS.....	22
5.40	MODIFIED LEASE PARAGRAPHS (OCT 2016).....	22

SECTION 1 THE PREMISES, RENT, AND OTHER TERMS

1.01 THE PREMISES (SEP 2015)

The Premises are described as follows:

A. Aviation Hangar and Operations Related Space: Aviation Hangar Building No. 806, with contiguous office / support space, consisting of 15,019 rentable square feet (RSF), yielding 15,019 ANSI/BOMA Office Area (ABOA) square feet (SF). The Lessor also grants to the Government access to, and use of all common areas located on the premises or associated with the leased space, including to, adjoining apron / ramp space, and 53 adjoining parking spaces, situated on approximately 1.76 acres (AC) of land as depicted on the Plat Map attached hereto as Exhibit B.

B. Common Area Factor: The Common Area Factor (CAF) is established as 0.0 percent. This factor, which represents the conversion from ABOA to rentable square feet, rounded to the nearest whole percentage, shall be used for purposes of rental adjustments in accordance with the Payment Clause of the General Clauses.

1.02 EXPRESS APPURTENANT RIGHTS (SEP 2013)

The Government shall have the non-exclusive right to the use of Appurtenant Areas and shall have the right to post Rules and Regulations Governing Conduct on Federal Property, Title 41, CFR, Part 102-74, Subpart C within such areas. The Government will coordinate with Lessor to ensure signage is consistent with Lessor's standards. Appurtenant to the Premises and included in the Lease are rights to use the following:

A. Parking: Approximately 53 surface/outside parking spaces are reserved for the exclusive use of the Government. The parking area is depicted on the Parking Plan attached hereto as Exhibit E. Parking is included in the rental payment for the Government. In addition, the Lessor shall provide such additional parking spaces as required by the applicable code of the local government entity having jurisdiction over the Property.

B. Antennas, Satellite Dishes and Related Transmission Devices: (1) Space located on the roof of the Building sufficient in size for the installation and placement of telecommunications equipment, (2) the right to access the roof of the Building, and (3) use of all Building areas (e.g., chases, plenums, etc.) necessary for the use, operation, and maintenance of such telecommunications equipment at all times during the term of this Lease. The Government acknowledges that the installation of antennas, satellite dishes, and related transmission devices are subject to the approval of the Federal Aviation Authority (FAA).

1.03 RENT AND OTHER CONSIDERATION (ON-AIRPORT) (OCT 2021)

A. The Government shall pay the Lessor annual rent payable monthly in arrears at the following rates. Rental payments, however, will not be due and owing until substantial completion of the tenant improvements described in this Lease and execution of a Supplemental Lease Amendment by the Parties, which will set forth the agreed final rental payments. In accordance with Paragraph 5.02, Tenant Improvement Rental Adjustment, if the Government elects to make a lump sum payment for the TI after occupancy, the payment of the TI by the Government will result in a decrease in the rent according to the amortization rate over the Firm Term of the Lease.

	FIRM TERM	NON-FIRM TERM
	ANNUAL RENT	ANNUAL RENT
	(YEARS 1 – 15)	(YEARS 16 - 20)
SHELL RENT (BUILDING) ¹	\$203,410.03	\$141,811.35
SHELL RENT (LAND) ²	\$ 29,324.97	\$ 39,031.53
OPERATING COSTS ³	\$ 1,456.00	\$2,214.39
TENANT IMPROVEMENTS RENT ⁴	\$ 94,174.98	\$ 0.00
BUILDING SPECIFIC AMORTIZED CAPITAL (BSAC) ⁵	\$ 0.00	\$ 0.00
PARKING ⁶	INCLUDED	INCLUDED
TOTAL ANNUAL RENT⁷	\$328,365.98	\$183,057.28

¹Shell rent calculation (Building):

(Firm Term) **\$13.5435** per RSF multiplied by the RSF stated under Paragraph 1.01

(Non Firm Term) **\$9.4421** per RSF multiplied by the RSF stated under Paragraph 1.01

²Shell rent calculation (Land):

(Firm Term) **\$0.3814** per RSF multiplied by the RSF stated under Paragraph 1.01

(Non Firm Term) **\$0.5076** per RSF multiplied by the RSF stated under Paragraph 1.01

³Operating Costs rent calculation: **\$0.1264** per RSF multiplied by the RSF stated under Paragraph 1.01

⁴Tenant Improvements of **\$930,005.55** are amortized at a rate of **6** percent per annum over **15** years.

⁵Building Specific Amortized Capital (BSAC) of **\$0.00** are amortized at a rate of **0** percent per annum over **0** years

⁶Parking costs described under sub-paragraph C below

⁷Total Annual Rent does not reflect reduction for free rent (if applicable).

B. Availability of Appropriations. Funds are not presently available for performance under this Lease. In accordance with federal fiscal law, the Government's obligation for performance of this Lease and every provision herein is contingent upon the availability of appropriated funds from which payment for contract purposes can be made. No legal liability on the part of the Government for any payment may arise for performance under this Lease until funds are made available to the LCO for performance. Nothing in this Lease may be considered as implying that Congress will at a later date appropriate funds sufficient to meet deficiencies. Payment of any future obligations arising under this Lease are subject to the discretion of the Lessee to prioritize its appropriated funds to meet competing agency obligations and the ongoing activities of the Lessee in support of its mission. The Government may terminate this lease if sufficient funding cannot be obligated.

C. Parking cost is included in the rental payment.

D. Rent is subject to adjustment based upon a mutual on-site measurement of the Space upon acceptance, not to exceed 15,019 ABOA SF based upon the methodology outlined under the "Payment" clause of GSA Form 3517 and not to exceed the amounts set forth above.

E. Rent is subject to adjustment upon reconciliation from quantities in the Lease to the approved DIDs and post-DID change orders.

F. If the Government occupies the Premises for less than a full calendar month, then rent shall be prorated based on the actual number of days of occupancy for that month.

G. Rent shall be paid to Lessor by electronic funds transfer (EFT) in accordance with the provisions of the General Clauses. Rent shall be payable using the EFT information contained in the System for Award Management (SAM). In the event the EFT information changes, the Lessor shall be responsible for providing the updated information to SAM. Failure by the Lessor to maintain an active registration in SAM may result in delay of rental payments until such time as the SAM registration is activated. This registration service is free of charge.

H. The Lessor shall provide to the Government, in exchange for the payment of rental and other specified consideration, the following:

1. The leasehold interest in the Property described herein in the paragraph entitled "The Premises,"

2. All costs, expenses and fees to perform the work required for acceptance of the Premises in accordance with this Lease, including all costs for labor, materials, and equipment, professional fees, contractor fees, attorney fees, permit fees, inspection fees, and similar such fees, and all related expenses;

3. Performance or satisfaction of all other obligations set forth in this Lease; and all services, utilities (with the exclusion of electricity, gas, water, and sewer), maintenance required for the proper operation of the Property, the Building, and the Leased Premises, in accordance with the terms of the Lease, including, but not limited to, all inspections, modifications, repairs, replacements and improvements required to be made thereto to meet the requirements of this Lease. The Lessor is not responsible for paying the cost of electricity, gas, water, and sewer. The Lessor shall ensure that such utilities are separately metered. The Lessor shall provide and install as part of shell rent, separate meters for utilities. Sub-meters are not acceptable. The Lessor shall furnish in writing to the LCO, prior to occupancy by the Government, a record of the meter numbers and verification that the meters measure Government usage only. Proration is not permissible.

4. The Lessor shall maintain the building structure, which shall include, but not limited to foundation, floor / ceiling slab, exterior walls, exterior glass, beams, columns, and the roof.

5. The Lessor shall furnish to the Government, as part of the rental consideration, exterior or grounds maintenance, which shall include, but are not limited to, costs and/or expenses to maintain parking areas, fence borders, landscaping including removal of weeds, watering of shrubs, and the repairing, replacement or replanting of said shrubbery.

6. The Lessor is not responsible for plumbing, lighting, and Government property.

7. The Lessor is not responsible for the janitorial services.

8. The Lessor is not responsible for maintenance on the Central HVAC system during the firm term of the Lease. The Lessor shall ensure the existing Central HVAC systems shall be fully operational prior to the Government's occupancy. The Lessor shall provide an inspection certificate prepared by a licensed engineer that verifies the equipment complies with current applicable codes. If anytime during the firm term of the lease that the Central HVAC is inoperable and beyond reasonable repair, the Lessor shall, at its own cost and expense, replace the system. The Lessor shall be responsible for maintenance of the Central HVAC system after the firm term of the Lease.

1.04 TERMINATION RIGHTS (ON-AIRPORT) (SEP 2013)

A. The Government may terminate this Lease, in whole or in part, at any time effective after the Firm Term of this Lease, by providing not less than 120 days' prior written notice to the Lessor. The effective date of the termination shall be the day following the expiration of the required notice period or the termination date set forth in the notice, whichever is later. No rental shall accrue after the effective date of termination.

1.05 ~~RENEWAL RIGHTS (OCT 2016)~~ INTENTIONALLY DELETED

1.06 DOCUMENTS INCORPORATED IN THE LEASE (ON-AIRPORT) (OCT 2020)

The following documents are attached to and made part of the Lease:

DOCUMENT NAME	NO. OF PAGES	EXHIBIT
GSA Form 3517B, General Clauses	17	A
Plat Map and Metes and Bounds Description	2	B
Floor Plan	1	C
Statement of Work / Agency Requirements and Design Schematic	11	D
Parking Plan	1	E
Small Business Subcontracting Plan – Notification To Offeror	3	F
Small Business Subcontracting Plan Template	7	Attachment 1
Subcontracting Report for Individual Contracts SF 294 (REV. 11/2021)	4	Attachment 2
GSAR 552.270-33 Foreign Ownership and Financing Representation for High-Security Leased Space	4	G
GSAR 552.270-34 Access Limitations for High-Security Leased Space	1	H
FAR 52.204-25 Prohibition on Contracting for Certain Telecommunications and Video Surveillance Services or Equipment (Deviation 20-05) (Dec 2020)	4	I
FAR 52.204-24 Representation Regarding Certain Telecommunications and Video Surveillance Services or Equipment.	1	J
FAA Provisions	4	K

1.07 OPERATING COST BASE (OCT 2016)

The Lessor has provided an annual Operating Cost of \$1,456.00 for the Firm term of the Lease which shall be \$0.1264 per RSF. The Lessor has provided an annual Operating Cost of \$2,214.39 for the Non-Firm term of the Lease which shall be \$0.1922 per RSF.

1.08 LESSOR'S UNIQUE ENTITY IDENTIFIER (OCT 2021)

Lessor's Unique Entity Identifier (UEI)

UEI-DUNS: N/A

UEI-SAM: KLZGKXNFVTL4

SECTION 2 GENERAL TERMS, CONDITIONS, AND STANDARDS

2.01 DEFINITIONS AND GENERAL TERMS (OCT 2016)

Unless otherwise specifically noted, all terms and conditions set forth in this Lease shall be interpreted by reference to the following definitions, standards, and formulas:

- A. Appurtenant Areas. Appurtenant Areas are defined as those areas and facilities on the Property that are not located within the Premises, but for which rights are expressly granted under this Lease, or for which rights to use are reasonably necessary or reasonably anticipated with respect to the Government's enjoyment of the Premises and express appurtenant rights.
- B. Building. Building(s) situated on the Property in which the Premises are located.
- C. Common Area Factor. The "Common Area Factor" (CAF) is a conversion factor determined by the Building owner and applied by the owner to the ABOA SF to determine the RSF for the leased Space. The CAF is expressed as a percentage of the difference between the amount of rentable SF and ABOA SF, divided by the ABOA SF. For example, 11,500 RSF and 10,000 ABOA SF will have a CAF of 15% [(11,500 RSF - 10,000 ABOA SF)/10,000 ABOA SF]. For the purposes of this Lease, the CAF shall be determined in accordance with the applicable ANSI/BOMA standard for the type of space to which the CAF shall apply.
- D. Contract. Contract shall mean this Lease.
- E. Contractor. Contractor shall mean Lessor.
- F. Days. All references to "day" or "days" in this Lease shall mean calendar days, unless specified otherwise.
- G. FAR. All references to the FAR shall be understood to mean the Federal Acquisition Regulation, codified at 48 CFR Chapter 1.
- H. Firm Term/Non-Firm Term. The Firm Term is that part of the Lease term that is not subject to termination rights. The Non-Firm Term is that part of the Lease term following the end of the Firm Term.
- I. GSAR. All references to the GSAR shall be understood to mean the GSA supplement to the FAR, codified at 48 CFR Chapter 5.
- J. Lease Term Commencement Date. The date on which the Lease term commences.
- K. Lease Award Date. The date the LCO executes the Lease and mails or otherwise furnishes written notification of the executed Lease to the successful Offeror (date on which the parties' obligations under the Lease begin).
- L. Premises. The Premises are defined as the total Office Area or other type of Space, together with all associated common areas, described in Section 1 of this Lease, and delineated by plan in the attached exhibit. Parking and other areas to which the Government has rights under this Lease are not included in the Premises.
- M. Property. The Property is defined as the land and Buildings in which the Premises are located, including all Appurtenant Areas (e.g., parking areas) to which the Government is granted rights.
- N. Rentable Space or Rentable Square Feet (RSF). Rentable Space is the area for which a tenant is charged rent. It is determined by the Building owner and may vary by city or by building within the same city. The Rentable Space may include a share of Building support/common areas such as elevator lobbies, Building corridors, and floor service areas. Floor service areas typically include restrooms, janitor rooms, telephone closets, electrical closets, and mechanical rooms. The Rentable Space does not include vertical building penetrations and their enclosing walls, such as stairs, elevator shafts, and vertical ducts. Rentable Square Feet is calculated using the following formula for each type of Space (e.g., office, warehouse, etc.) included in the Premises: $ABOA\ SF\ of\ Space \times (1 + CAF) = RSF$.
- O. Space. The Space shall refer to that part of the Premises to which the Government has exclusive use, such as Office Area, or other type of Space. Parking areas to which the Government has rights under this Lease are not included in the Space.
- P. Office Area. For the purposes of this Lease, Space shall be measured in accordance with the standard (Z65.1-1996) provided by American National Standards Institute/Building Owners and Managers Association (ANSI/BOMA) for Office Area, which means "the area where a tenant normally houses personnel and/or furniture, for which a measurement is to be computed." References to ABOA mean ANSI/BOMA Office Area.
- Q. Working Days. Working Days shall mean weekdays, excluding Saturdays and Sundays and Federal holidays.

2.02 AUTHORIZED REPRESENTATIVES (OCT 2016)

Signatories to this Lease shall have full authority to bind their respective principals with regard to all matters relating to this Lease. No other persons shall be understood to have any authority to bind their respective principals, except to the extent that such authority may be explicitly delegated by notice to the other party, or to the extent that such authority is transferred by succession of interest. The Government shall have the right to substitute its Lease Contracting Officer (LCO) by notice, without an express delegation by the prior LCO.

2.03 ALTERATIONS REQUESTED BY THE GOVERNMENT (OCT 2018)

A. The Government may request the Lessor to provide alterations during the term of the Lease. Alterations will be ordered by issuance of a Lease Amendment, GSA Form 300, Order for Supplies or Services, or a tenant agency-approved form when specifically authorized to do so by the LCO. The General Services Administration Acquisition Manual ("GSAM") clause, 552.270-31, Prompt Payment, including its invoice requirements, shall apply to orders for alterations. All orders are subject to the terms and conditions of this Lease and may be placed by the LCO or a warranted contracting officer's representative (COR) in CBP or the tenant agency when specifically authorized to do so by the LCO, subject to the threshold limitation below.

B. Orders for alterations issued by an authorized COR are limited to no more than \$250,000 (LCOs are not subject to this threshold). This threshold will change according to future adjustments of the simplified acquisition threshold (see FAR 2.101). The LCO will provide the Lessor with a list of tenant agency officials authorized to place orders and will specify any limitations on the authority delegated to tenant agency officials. The tenant agency officials are not authorized to deal with the Lessor on any other matters.

C. Payments for alterations ordered by the tenant agency under the authorization described in sub-paragraph B will be made directly by the tenant agency placing the order.

2.04 WAIVER OF RESTORATION (OCT 2021)

Lessor shall have no right to require the Government to restore the Premises upon expiration or earlier termination (full or partial) of the Lease, and waives all claims against the Government for:

- a) waste, or,
- b) damages or restoration arising from or related to:
 - (1) the Government's normal and customary use of the Premises during the term of the Lease (including any extensions thereof), as well as
 - (2) any initial or subsequent alteration to the Premises regardless of whether such alterations are performed by the Lessor or by the Government.

At its sole option, the Government may abandon property in the Space following expiration or earlier termination (full or partial) of the Lease, in which case the property will become the property of the Lessor and the Government will be relieved of any liability in connection therewith.

2.05 ~~OPERATING COSTS ADJUSTMENT (JUN 2012)~~ INTENTIONALLY DELETED

2.06 CHANGE OF OWNERSHIP/NOVATION (OCT 2021)

A. If during the term of the Lease, title to the Property is transferred or the Lessor changes its legal name, the Lessor and its successor shall comply with the requirements of FAR Subpart 42.12. If title is transferred, the Lessor shall notify the Government within five days of the transfer of title.

B. The Government and the Lessor may execute a Change of Name Agreement if the Lessor is changing only its legal name, and the Government's and the Lessor's respective rights and obligations remain unaffected.

C. If title to the Property is transferred, the Government, the original Lessor (Transferor), and the new owner or assignee (Transferee) shall execute a Novation Agreement providing for the transfer of Transferor's rights and obligations under the Lease to the Transferee. When executed on behalf of the Government, a Novation Agreement will be made part of the Lease via Lease Amendment.

D. In addition to all documents required by FAR 42.1204, the LCO may request additional information (e.g., copy of the deed, bill of sale, certificate of merger, contract, court decree, articles of incorporation, operation agreement, partnership certificate of good standing, etc.) from the Transferor or Transferee to verify the parties' representations regarding the transfer, and to determine whether the transfer of the Lease is in the Government's interest.

E. If the LCO determines that recognizing the Transferee as the Lessor will not be in the Government's interest, the Transferor shall remain fully liable to the Government for the Transferee's performance of obligations under the Lease, notwithstanding the transfer. Under no condition shall the Government be obligated to release the Transferor of obligations prior to (a) the rent commencement date; and (b) any amounts due and owing to the Government under the Lease that have been paid in full or completely set off against the rental payments due under the Lease.

F. As a condition for being recognized as the Lessor and entitlement to receiving rent, the Transferee must register in the System for Award Management (SAM) for purposes of "All Awards" (See FAR 52.232-33), and complete all required representations and certifications within SAM. In addition, for leases FSL III or above, the Transferee must also complete 552.270-33 Foreign Ownership and Financing Representation for High Security Leased Space. This representation must be completed annually.

G. If title to the Property is transferred, rent shall continue to be paid to the original Lessor, subject to the Government's rights as provided for in this Lease. The Government's obligation to pay rent to the Transferee shall commence on the effective date of the Lease Amendment incorporating the Novation Agreement. The Lease Amendment will not be issued until the Government has received all information reasonably required by the LCO, the Government has determined that recognizing the Transferee as the Lessor is in the Government's interest (which determination will be prompt and not unreasonably withheld), and the Transferee has met all conditions specified in sub-paragraph F. The original Lessor must maintain an active registration in SAM until the Novation process is complete.

2.07 ~~RELOCATION RIGHTS (OCT 2021)~~ INTENTIONALLY DELETED

2.08 ~~RECITALS FOR TRANSPORTATION SECURITY ADMINISTRATION (ON AIRPORT) (JUN 2012)~~ INTENTIONALLY DELETED

2.09 ACCEPTANCE OF SPACE AND CERTIFICATE OF OCCUPANCY (ON-AIRPORT) (MAY 2015)

A. The Lessor shall provide floor plans for the Space and a valid Certificate of Occupancy (C of O), issued by the local jurisdiction, for the intended use of the Government. If the local jurisdiction does not issue C of O's or if the C of O is not available, the Lessor may satisfy this condition by providing a report prepared by a licensed fire protection engineer that verifies that the Space complies with all applicable local fire protection and life safety codes and ordinances and all fire protection and life safety-related requirements of this Lease.

B. Neither the Government's acceptance of the Premises for occupancy or acceptance of related appurtenances, nor the Government's occupancy of the Premises, shall be construed as a waiver of any requirement or right of the Government under this lease, or as otherwise prejudicing the Government with respect to any such requirement or right, or as an acceptance of any latent defect or condition.

2.10 ALTERATIONS PRIOR TO ACCEPTANCE (JUN 2012)

The Government's rights stated under the General Clause "Alterations" also apply to initial build-out of the Premises.

2.11 SYSTEM FOR AWARD MANAGEMENT (MAR 2020)

The Offeror must have an active registration in the System for Award Management (SAM), via the Internet at, <https://www.sam.gov/SAM/> prior to the Lease Award Date. Registration must be for purposes of "All Awards" and include completion of all required representations and certifications within SAM. Registration must be active throughout the life of the Lease. To remain active, the Offeror/Lessor is required to update or renew its registration annually. The Government will not process rent payments to Lessors without an active registration in SAM. No change of ownership of the leased Premises will be recognized by the Government until the new owner registers in SAM.

2.12 SECURITY UPGRADES DUE TO IMMEDIATE THREAT (APR 2011)

The Government reserves the right, at its own expense and with its own personnel, to heighten security in the Building under Lease during heightened security conditions due to emergencies such as terrorist attacks, natural disaster, and civil unrest.

SECTION 3 CONSTRUCTION STANDARDS AND SHELL COMPONENTS

3.01 BUILDING SHELL REQUIREMENTS (ON-AIRPORT) (SEP 2013)

A. The Building Shell shall be designed, constructed, and maintained in accordance with the standards set forth herein and completed prior to acceptance of Space. For pricing, fulfillment of all requirements not specifically designated as operating costs or other rent components as indicated shall be deemed included in the Shell Rent.

B. Base structure and Building enclosure components shall be complete. All common areas accessible by the Government, such as lobbies, fire egress corridors and stairwells, elevators, garages, and service areas, shall be complete. Restrooms shall be complete and operational. All newly installed Building shell components, including but not limited to, heating, ventilation, and air conditioning (HVAC), electrical, ceilings, sprinklers, etc., shall be furnished, installed, and coordinated with TIs. Circulation corridors are provided as part of the base Building only on multi-tenanted floors where the corridor is common to more than one tenant. On single tenant floors, only the fire egress corridor(s) necessary to meet code is provided as part of the shell.

3.02 MEANS OF EGRESS (MAY 2015)

A. Prior to occupancy, the Premises shall meet or will be upgraded to meet, either the applicable egress requirements in the National Fire Protection Association, Life Safety Code (NFPA 101), or the International Code Council, International Building Code (IBC), each current as of the Lease Award Date, or use an alternative approach or method that achieves an equivalent level of safety deemed acceptable by the Government.

B. The Space shall have unrestricted access to a minimum of two remote exits on each floor of Government occupancy.

C. Doors shall not be locked in the direction of egress unless equipped with special locking hardware in accordance with requirements of NFPA 101 or the IBC.

3.03 AUTOMATIC FIRE SPRINKLER SYSTEM (SEP 2013)

A. Any portion of the Space located below-grade, including parking garage areas, and all areas in a Building referred to as "hazardous areas" (defined in National Fire Protection Association (NFPA) 101) that are located within the entire Building (including non-Government areas) shall be protected by an automatic fire sprinkler system or an equivalent level of safety.

B. For Buildings in which any portion of the Space is on or above the sixth floor, then, at a minimum, the Building up to and including the highest floor of Government occupancy shall be protected by an automatic fire sprinkler system or an equivalent level of safety.

C. For Buildings in which any portion of the Space is on or above the sixth floor, and lease of the Space will result, either individually or in combination with other Government Leases in the Building, in the Government leasing 35,000 or more ANSI/BOMA Office Area SF of Space in the Building, then the entire Building shall be protected throughout by an automatic fire sprinkler system or an equivalent level of safety.

D. Automatic fire sprinkler system(s) shall be installed in accordance with the requirements of NFPA 13, Standard for the Installation of Sprinkler Systems that was in effect on the actual date of installation.

E. Automatic fire sprinkler system(s) shall be maintained in accordance with the requirements of NFPA 25, Standard for the Inspection, Testing, and Maintenance of Water-based Fire Protection Systems (current as of the Lease Award Date).

F. "Equivalent level of safety" means an alternative design or system (which may include automatic fire sprinkler systems), based upon fire protection engineering analysis, which achieves a level of safety equal to or greater than that provided by automatic fire sprinkler systems.

3.04 FIRE ALARM SYSTEM (SEP 2013)

A. A Building-wide fire alarm system shall be installed in the entire Building in which any portion of the Space is located on the 3rd floor or higher.

B. The fire alarm system shall be installed in accordance with the requirements of NFPA 72, National Fire Alarm and Signaling Code that was in effect on the actual date of installation.

C. The fire alarm system shall be maintained in accordance with the requirements of NFPA 72, National Fire Alarm and Signaling Code (current as of the Lease Award Date).

D. The fire alarm system shall transmit all fire alarm signals to the local fire department via any of the following means: directly to the local fire department, to the (911) public communications center, to a central station, to a remote supervising station, or to a proprietary supervising station.

E. If the Building's fire alarm control unit is over 25 years old as of the Lease Award Date, Lessor shall install a new fire alarm system in accordance with the requirements of NFPA 72, National Fire Alarm and Signaling Code (current as of the Lease Award Date), prior to Government acceptance and occupancy of the Space.

3.05 ~~ENERGY INDEPENDENCE AND SECURITY ACT (DEC 2014)~~ INTENTIONALLY DELETED

3.06 ACCESSIBILITY (FEB 2007)

The Building, leased Space, and areas serving the leased Space shall be accessible to persons with disabilities in accordance with the Architectural Barriers Act Accessibility Standard (ABAAS), Appendices C and D to 36 CFR Part 1191 (ABA Chapters 1 and 2, and Chapters 3 through 10). To the extent the standard referenced in the preceding sentence conflicts with local accessibility requirements, the more stringent shall apply.

3.07 MECHANICAL, ELECTRICAL, PLUMBING: GENERAL (APR 2011)

The Lessor shall provide and operate all Building equipment and systems in accordance with applicable technical publications, manuals, and standard procedures, prior to Space acceptance. Mains, lines, and meters for utilities shall be provided by the Lessor. Exposed ducts, piping, and conduits are not permitted in office Space.

3.08 ~~RESTROOMS (ON-AIRPORT) (JUN 2012)~~ INTENTIONALLY DELETED

3.09 HEATING, VENTILATION, AND AIR CONDITIONING (ON-AIRPORT) (APR 2011)

A. Temperatures shall conform to local commercial equivalent temperature levels and operating practices to maximize tenant satisfaction. These temperatures shall be maintained throughout the leased Premises and service areas, regardless of outside temperatures, during the hours of operation specified in this Lease. The Government shall perform any necessary systems start-up required to meet the commercially equivalent temperature levels prior to the first hour of each day's operation. At all times, humidity shall be maintained below 60 percent relative humidity.

B. Normal HVAC systems maintenance shall not disrupt tenant operations.

3.10 TELECOMMUNICATIONS: LOCAL EXCHANGE ACCESS (ON-AIRPORT) (SEP 2013)

A. The Government may elect to contract its own telecommunications (voice, data, video, Internet, or other emerging technologies) service in the Space. The Government may contract with one or more parties to have inside wiring (or other transmission medium) and telecommunications equipment installed.

B. The Lessor shall allow the Government's designated telecommunications providers access to utilize existing Building wiring to connect its services to the Government's Space. If the existing Building wiring is insufficient to handle the transmission requirements of the Government's designated telecommunications providers, the Lessor shall provide access from the point of entry into the Building to the Government's floor Space, subject to any inherent limitations in the pathway involved.

C. The Lessor shall allow the Government's designated telecommunications providers to affix telecommunications antennas (high frequency, mobile, microwave, satellite, or other emerging technologies), subject to weight and wind load conditions, to roof, parapet, or Building envelope as required.

3.11 GOVERNMENT PROJECT MANAGEMENT SYSTEM (ON-AIRPORT) (OCT 2021)

The Government may direct the Lessor to use the Government's designated project management system for post-award and post-occupancy activities.

SECTION 4 UTILITIES, SERVICES, AND OBLIGATIONS DURING THE LEASE TERM

4.01 SERVICES, UTILITIES, AND MAINTENANCE (ON-AIRPORT) (OCT 2020)

The Lessor is responsible for providing all utilities necessary for base building and tenant operations prior to acceptance of Space. The following services and maintenance shall be provided by the Lessor as part of the rental consideration (check all that apply):

- | | | | | |
|---|---|---|--|---|
| <input type="checkbox"/> HEAT | <input type="checkbox"/> TRASH REMOVAL | <input type="checkbox"/> ELEVATOR SERVICE | <input type="checkbox"/> INITIAL & REPLACEMENT LAMPS, TUBES & BALLASTS | <input checked="" type="checkbox"/> OTHER |
| <input type="checkbox"/> ELECTRICITY | <input type="checkbox"/> CHILLED DRINKING WATER | <input type="checkbox"/> WINDOW WASHING | | (Specify below) |
| <input type="checkbox"/> POWER (Special Equip.) | <input type="checkbox"/> AIR CONDITIONING | Frequency _____ | <input checked="" type="checkbox"/> PAINTING FREQUENCY | CARPET REPLACEMENT 10 |
| <input type="checkbox"/> WATER (Hot & Cold) | <input type="checkbox"/> RESTROOM SUPPLIES | <input type="checkbox"/> CARPET CLEANING | Space 10 Years | Years |
| <input type="checkbox"/> SNOW REMOVAL | <input type="checkbox"/> JANITORIAL SERV. & SUPP. | Frequency _____ | | |

A. The Lessor shall perform cyclical repainting of the interior and exterior Space every ten (10) years of occupancy. This cost, including the moving and returning of furnishings, as well as disassembly and reassembly of systems furniture per manufacturer's warranty, shall be at the Lessor's expense.

B. Carpet and flooring.

1. Except when damaged by the Government, the Lessor shall repair or replace flooring at any time during the Lease term when:

- a. Backing or underlayment is exposed;
- b. There are noticeable variations in surface color or texture;
- c. It has curls, upturned edges, or other noticeable variations in texture;
- d. Tiles are loose; or,
- e. Tears or tripping hazards are present.

2. Repair or replacement shall include the moving and returning of furnishings, including disassembly and reassembly of systems furniture per manufacturer's warranty, if necessary. Work shall be performed after normal hours.

C. The Lessor shall replace all carpet and base covering in the Space every ten (10) years, with a product which meets the requirements in the "Floor Coverings and Perimeters" paragraph in this Lease.

4.02 PROVISION OF SERVICES, ACCESS, AND NORMAL HOURS FOR AIRPORT OCCUPANCIES (SEP 2013)

The Government shall have access to the Premises and its Appurtenant Areas at all times without additional payment.

4.03 ~~MAINTENANCE AND TESTING OF SYSTEMS (SEP 2013)~~ INTENTIONALLY DELETED

4.04 RECYCLING (ON-AIRPORT) (JUN 2012)

Where state or local law, code, or ordinance requires recycling programs (including mercury-containing lamps) for the Space to be provided pursuant to this Lease, the Lessor shall comply with such state and local law, code, or ordinance in accordance with GSA Form 3517, General Clauses, 552.270-8, *Compliance with Applicable Law*. During the lease term, the Lessor agrees, upon request, to provide the Government with additional information concerning recycling programs maintained in the Building and in the Leased Space.

4.05 RANDOLPH-SHEPPARD COMPLIANCE (SEP 2013)

During the term of the Lease, the Lessor may not establish vending facilities within the leased Space that will compete with any Randolph-Sheppard vending facilities.

4.06 SAFEGUARDING AND DISSEMINATION OF CONTROLLED UNCLASSIFIED INFORMATION (CUI) BUILDING INFORMATION (FEB 2020)

This clause applies to all recipients of CUI building information (which falls within the CUI Physical Security category), including offerors, bidders, awardees, contractors, subcontractors, lessors, suppliers and manufacturers.

Marking CUI. Contractors must submit any contractor-generated documents that contain building information to CBP for review and identification of any CUI building information that may be included. In addition, any documents CBP identifies as containing CUI building information must be marked in accordance with the Order and the Marking Controlled Unclassified Information Handbook (the current version may be found at <https://www.archives.gov/files/cui/20161206-cui-marking-handbook-v1-1.pdf>) before the original or any copies are disseminated to any other parties. If CUI content is identified, the LCO may direct the contractor, as specified elsewhere in this contract, to imprint or affix CUI document markings (CUI) to the original documents and all copies, before any dissemination, or authorized CBP employees may mark the documents.

1. Authorized recipients.

- a. Building information designated as CUI must be protected with access strictly controlled and limited to those individuals having a Lawful Government Purpose to access such information, as defined in 32 C.F.R. § 2002.4(bb). Those with such a Lawful Government Purpose may include Federal, state and local government entities, and non-governmental entities engaged in the conduct of business on behalf of or with CBP. Non-governmental entities may include architects, engineers, consultants, contractors, subcontractors, suppliers, utilities, and others submitting an offer or bid to CBP, or performing work under a CBP contract or subcontract. Recipient contractors must be registered as "active" in the System for Award Management (SAM) database at www.sam.gov, and have a Lawful Government Purpose to access such information. If a subcontractor is not registered in the SAM database and has a Lawful Government Purpose to possess CUI building information in furtherance of the contract, the subcontractor must provide to the contractor its DUNS number or its tax ID number and a copy of its business license. The contractor must keep this information related to the subcontractor for the duration of the contract and subcontract.
 - b. All CBP personnel and contractors must be provided CUI building information when needed for the performance of official Federal, state, and local government functions, such as for code compliance reviews and the issuance of building permits. Public safety entities such as fire and utility departments may have a Lawful Government Purpose to access CUI building information on a case-by-case basis. This clause must not prevent or encumber the necessary dissemination of CUI building information to public safety entities.
2. **Dissemination of CUI building information:**
- a. **By electronic transmission.** Electronic transmission of CUI information outside of the CBP network must use session encryption (or alternatively, file encryption) consistent with National Institute of Standards and Technology (NIST) SP 800-171. Encryption must be through an approved NIST algorithm with a valid certification, such as Advanced Encryption Standard or Triple Data Encryption Standard, in accordance with Federal Information Processing Standards Publication 140-2, Security Requirements for Cryptographic Modules, as required by CBP policy.
 - b. **By nonelectronic form or on portable electronic data storage devices.** Portable electronic data storage devices include CDs, DVDs, and USB drives. Nonelectronic forms of CUI building information include paper documents, photographs, and film, among other formats.
 - i. **By mail.** Contractors must only use methods of shipping that provide services for monitoring receipt such as track and confirm, proof of delivery, signature confirmation, or return receipt.
 - ii. **In person.** Contractors must provide CUI building information only to authorized recipients with a Lawful Government Purpose to access such information. Further information on authorized recipients is found in section 1 of this clause.
3. **Record keeping.** Contractors must maintain a list of all entities to which CUI is disseminated, in accordance with sections 2 and 3 of this clause. This list must include, at a minimum:
- a. The name of the state, Federal, or local government entity, utility, or firm to which CUI has been disseminated;
 - b. The name of the individual at the entity or firm who is responsible for protecting the CUI building information, with access strictly controlled and limited to those individuals having a Lawful Government Purpose to access such information;
 - c. Contact information for the named individual; and
 - d. A description of the CUI building information provided.

Once "as built" drawings are submitted, the contractor must collect all lists maintained in accordance with this clause, including those maintained by any subcontractors and suppliers, and submit them to the LCO. For Federal buildings, final payment may be withheld until the lists are received.

4. **Safeguarding CUI documents.** CUI building information (both electronic and paper formats) must be stored within controlled environments that prevent unauthorized access. CBP contractors and subcontractors must not take CUI building information outside of CBP or their own facilities or network, except as necessary for the performance of that contract. Access to the information must be limited to those with a Lawful Government Purpose for access.
5. **Destroying CUI building information.** When no longer needed, CUI building information must either be returned to the LCO or destroyed in accordance with guidelines in NIST Special Publication 800-88, Guidelines for Media Sanitization.
6. **Notice of disposal.** The contractor must notify the LCO that all CUI building information has been returned or destroyed by the contractor and its subcontractors or suppliers in accordance with paragraphs 4 and 5 of this clause, with the exception of the contractor's record copy. This notice must be submitted to the LCO at the completion of the contract to receive final payment. For leases, this notice must be submitted to the LCO at the completion of the lease term.
7. **CUI security incidents.** All improper disclosures or receipt of CUI building information must be immediately reported to the LCO. If the contract provides for progress payments, the LCO may withhold approval of progress payments until the contractor provides a corrective action plan explaining how the contractor will prevent future improper disclosures of CUI building information. Progress payments may also be withheld for failure to comply with any provision in this clause until the contractor provides a corrective action plan explaining how the contractor will rectify any noncompliance and comply with the clause in the future.
8. **Subcontracts.** The contractor and subcontractors must insert the substance of this clause in all subcontracts.

4.07 INDOOR AIR QUALITY (OCT 2019)

A. The Lessor shall control airborne contaminants at the source and/or operate the Space in such a manner that indoor air quality action limits identified in the PBS Desk Guide for Indoor Air Quality Management (Companion to GSA Order PBS 1000.8), OSHA regulatory limits, and generally accepted consensus standards are not exceeded.

B. The Lessor shall avoid the use of products containing toxic, hazardous, carcinogenic, flammable, or corrosive ingredients as determined from the product label or manufacturer's safety data sheet. The Lessor shall use available odor-free or low odor products when applying paints, glues, lubricants, and similar wet products. When such equivalent products are not available, lessor shall use the alternate products outside normal working

hours. Except in an emergency, the Lessor shall provide at least 72 hours advance notice to the Government before applying chemicals or products with noticeable odors in occupied Spaces and shall adequately ventilate those Spaces during and after application.

C. The Government reserves the right to conduct independent IAQ assessments and detailed studies in Space that it occupies, as well as in space serving the Space (e.g., common use areas, mechanical rooms, HVAC systems, etc.). The Lessor shall assist the Government in its assessments and detailed studies by:

1. Making available information on Building operations and Lessor activities;
2. Providing access to Space for assessment and testing, if required; and
3. Implementing corrective measures required by the LCO. The Lessor shall take corrective action to correct any tests or measurements that do not meet CBP policy action limits in the PBS Desk Guide for Indoor Air Quality Management (Companion to GSA Order PBS 1000.8), OSHA regulatory limits and generally accepted consensus standards.

D. The Lessor shall provide to the Government safety data sheets (SDS) upon request for the following products prior to their use during the term of the Lease: adhesives, caulking, sealants, insulating materials, fireproofing or firestopping materials, paints, carpets, floor and wall patching or leveling materials, lubricants, clear finish for wood surfaces, janitorial cleaning products, pesticides, rodenticides, and herbicides. The Government reserves the right to review such products used by the Lessor within the Space, common building areas, ventilation systems and zones serving the Space, and the area above suspended ceilings and engineering space in the same ventilation zone as the Space.

4.08 HAZARDOUS MATERIALS (ON-AIRPORT) (OCT 2021)

The leased Space shall be free of hazardous materials, hazardous substances, and hazardous wastes, as defined by and according to applicable Federal, state, and local environmental regulations including, but not limited to, the following:

A. The leased Space shall be free of all asbestos containing materials, except undamaged asbestos flooring in the Space or undamaged boiler or pipe insulation outside the Space, in which case an asbestos management program conforming to EPA guidance shall be implemented.

B. The Lessor shall provide Space to the Government that is free from ongoing water leaks or moisture infiltration. The Space and ventilation zones serving the Space shall also be free of visible mold or actionable airborne mold.

1. Actionable mold is either visible mold or airborne mold of types and concentrations in excess of that found in the local outdoor air or non-problematic control areas elsewhere in the same building, whichever is lower. The Lessor shall safely remediate all actionable mold in accordance with sub-paragraph B.2 below

2. The Lessor shall be responsible for conducting the remediation in accordance with the relevant provisions of the document entitled "Mold Remediation in Schools and Commercial Buildings" (EPA 402-K-01-001, September 2008 or ANSI/IICRC S520-2015 Standard for Professional Mold Remediation), published by EPA, as same may be amended or revised from time to time, and any other applicable Federal, state, or local laws, regulatory standards, and guidelines.

3. The Lessor acknowledges and agrees that the Government shall have a reasonable opportunity to inspect the leased Space after conclusion of the remediation. If the results of the Government's inspection indicate that the remediation does not comply with the plan or any other applicable Federal, state, or local laws, regulatory standards, or guidelines, the Lessor, at its sole cost, expense, and risk, shall immediately take all further actions necessary to bring the remediation into compliance.

4. If the Lessor fails to exercise due diligence, or is otherwise unable to remediate the actionable mold, the Government may implement a corrective action program and deduct its costs from the rent.

4.09 OCCUPANT EMERGENCY PLANS (OCT 2020)

The Lessor is required to cooperate, participate and comply with the development and implementation of the Government's Occupant Emergency Plan (OEP) and a supplemental Shelter-in Place (SIP) Plan. Periodically, the Government may request that the Lessor assist in reviewing and revising its OEP and SIP. The Plan, among other things, will include evacuation procedures and an annual emergency evacuation drill, emergency shutdown of air intake procedures, and emergency notification procedures for the Lessor's Building engineer or manager, Building security, local emergency personnel, and Government agency personnel.

SECTION 5 ADDITIONAL TERMS AND CONDITIONS

5.01 PROVISIONAL ACCEPTANCE (FEB 2021)

A. At a time of exceptional circumstance, i.e., pandemic, the Government may accept the Space on a provisional basis until such time that a re-inspection on-site can occur. In this instance and upon request from the LCO, the Lessor shall provide such documentation (e.g., picture(s), video(s) and/or a representative on-site for a live-stream or 'virtual' walkthrough) to confirm substantial completion. In such an instance the Government may withhold a percentage of lump sum Tenant Improvement payment as a reserve to ensure that all deficiencies and/or punch list item(s) will be addressed by the Lessor within the time frame established or until the Government can determine the space has been delivered in accordance with the Lease requirements, Design Intent Drawings and Construction Drawings.

B. At such time as a physical on-site inspection is deemed possible by the Government, the Government reserves the right to physically inspect the Space with an on-site representative to conduct a space measurement and to document any deficiencies and/or punch-list item(s) for the Lessor's correction.

C. Upon re-inspection and Government acceptance of any deficiencies and/or punch list item(s) documented per above, or in the instance of no such documented items, this provisional acceptance will be rendered non-provisional and fully accepted by the Government via subsequent Lease Amendment.

5.02 TENANT IMPROVEMENT RENTAL ADJUSTMENT (OCT 2016)

A. The Lessor has agreed to total TI pricing of \$930,005.55 based on the Agency's Requirements and design schematic included in Exhibit D. This amount is amortized in the rent over the Firm Term of this Lease at an interest rate of six (6) percent per year.

B. The Government may elect to make lump sum payments for any or all work covered by the TI scope. That part of the TI amortized in the rent shall be reduced accordingly. At any time after occupancy and during the Firm Term of the Lease, the Government, at its sole discretion, may elect to pay lump sum for any part or all of the remaining unpaid amortized balance of the TI. If the Government elects to make a lump sum payment for the TI after occupancy, the payment of the TI by the Government will result in a decrease in the rent according to the amortization rate over the Firm Term of the Lease.

5.03 QUALITY AND APPEARANCE OF BUILDING (JUN 2012)

The Building in which the Premises are located shall be designed, built and maintained in good condition and in accordance with the Lease requirements. If not new or recent construction, the Building shall have undergone by occupancy, modernization, or adaptive reuse for office space with modern conveniences. The Building shall be compatible with its surroundings. Overall, the Building shall project a professional and aesthetically pleasing appearance including an attractive front and entrance way.

5.04 DEMOLITION (JUN 2012)

The Lessor shall remove existing abandoned electric, telephone, and data cabling and devices, as well as any other improvements or fixtures in place to accommodate the Government's requirements. Any demolition of existing improvements that is necessary to satisfy the Government's layout shall be done at the Lessor's expense.

5.05 FLOOR COVERING AND PERIMETERS – SHELL (SLAT) (OCT 2020)

Flooring material through Building common areas shall be of quality materials, as approved by the LCO.

5.06 ELECTRICAL (SLAT) (OCT 2020)

A. The Lessor shall be responsible for meeting the applicable requirements of local codes and ordinances. When codes conflict, the more stringent standard shall apply.

B. All power distribution equipment shall be required to handle the actual specified and projected loads and 10 percent spare load capacity. Fuses and circuit breakers shall be plainly marked or labeled to identify circuits or equipment supplied through them.

C. Convenience outlets shall be installed in accordance with NFPA Standard 70, National Electrical Code, or local code, whichever is more stringent. The Lessor shall provide duplex utility outlets in restrooms, corridors, and dispensing areas.

5.07 ADDITIONAL ELECTRICAL CONTROLS (JUN 2012)

If the Government pays separately for electricity, no more than 500 SF of office may be controlled by one switch or automatic light control for all office Space on the Government meter, whether through a building automation system, time clock, occupant sensor, or other comparable system acceptable to the LCO.

5.08 DRINKING FOUNTAINS (OCT 2018)

On each floor of Government-occupied Space, the Lessor shall provide a minimum of two drinking fountains with chilled potable water within 200 feet of travel from any Government-occupied area on the floor. The fountains shall comply with Section F211 of the Architectural Barriers Act Accessibility Standard. Potable is defined as water meeting current EPA primary drinking water standards or more stringent, applicable state or local regulations. The Lessor shall serve as first responder to any occupant complaints about drinking water. The Lessor shall promptly investigate any such complaints and implement the necessary controls to address the complaints and maintain potable water conditions.

5.09 LIGHTING: INTERIOR AND PARKING – SHELL (SLAT) (OCT 2020)

A. INTERIOR FIXTURES: T-8, T-5, or LED light fixtures (and associated ballasts or drivers) shall be installed as either ceiling grid or pendant mounted for an open-office plan. Ceiling grid fixtures shall be either 2' wide by 4' long or 2' wide by 2' long. Lessor shall provide, as part of Shell Rent, a minimum overall lighting fixture efficiency of 85 percent. Lamps shall maintain a uniform color level throughout the lease term.

B. LIGHTING LEVELS: Fixtures shall have a minimum of two tubes and shall provide 50 foot-candles at desktop level (30" above finished floor) with a maximum uniformity ratio of 1.5:1. Lessor shall provide, as part of Shell Rent, 10 average foot-candles in all other Building areas within the Premises with a uniformity ratio of 4:1. Emergency egress lighting levels shall be provided in accordance with the local applicable building codes (but not less than 1 foot-candle) by either an onsite emergency generator or fixture mounted battery packs.

C. POWER DENSITY: The maximum fixture power density shall not exceed 1.4 watts per ABOA SF.

D. OCCUPANCY SENSORS: The Lessor shall provide occupancy sensors to reduce the hours that the lights are on when the Space is unoccupied

E. BUILDING PERIMETER: Exterior parking areas, vehicle driveways, pedestrian walks, and the Building perimeter lighting levels shall be designed per Illuminating Engineering Society (IES) standards. Provide 5 foot-candles for doorway areas, 3 foot-candles for transition areas and at least 1 foot-candle at the surface throughout the parking lot. Parking lot fixtures shall provide a maximum to minimum uniformity ratio of 15:1 and a maximum to average uniformity ratio of 4:1.

F. EXTERIOR POWER BACKUP: Exterior egress, walkway, parking lot, and parking structure lighting must have emergency power backup to provide for safe evacuation of the Building.

5.10 WORK PERFORMANCE (JUN 2012)

All work in performance of this Lease shall be done by skilled workers or mechanics and shall be acceptable to the LCO. The LCO may reject the Lessor's workers 1) if such are unlicensed, unskilled, or otherwise incompetent, or 2) if such have demonstrated a history of either untimely or otherwise unacceptable performance in connection with work carried out in conjunction with either this contract or other government or private contracts. Work may be rejected if it fails to conform to approved design drawings and quality standards.

5.11 SCHEDULE FOR COMPLETION OF SPACE (OCT 2020)

Design and construction activities for the Space shall commence upon Lease award. The Lessor shall schedule the following activities to achieve timely completion of the work required by this Lease:

A. Lessor-Provided Design Intent Drawings (DIDs): The Lessor must submit to CBP, as part of the shell cost, **65%** DIDs conforming to the requirements of this Lease and other Government-supplied information related to the tenant agency's interior build-out requirements not later than forty-five (45) Working Days following the Lease Award Date, provided that the Government supplies such information and direction as reasonably required for Lessor to timely complete DIDs. The Lessor shall submit the **95%** DIDs within ten (10) Working Days of the Government's approval of the **65%** DIDs. The Lessor shall submit the **100%** complete DIDs to the Government within five (5) Working Days of the Government's approval of the **95%** DIDs. The Government shall attend two meetings at the Lessor's request for the purpose of providing information and direction in the development of DIDs. These meetings may be held either in person or virtually, at the discretion of the Government. The Lessor should anticipate at least two submissions of DIDs before receiving approval. At the sole discretion of the Government, the Lessor may be required to submit a budget proposal based on the TIs and associated work as shown on the DIDs. This budget proposal shall be completed, as part of the shell cost, within seven (7) Working Days of the Government's request.

B. DIDs. For the purposes of this Lease, DIDs are defined as layout line drawings of the leased Space, reflecting all Lease requirements, showing partitions and doors; schematic demolition; voice, data, and electrical outlet locations; finishes; generic furniture layout, and any additional details necessary to communicate the design intent to the lessor's architect for the purpose of preparing the construction documents (CDs). A full DID set must include the following elements:

Level 1 (included in Shell rent):

1. Cover Sheet;
2. Demolition Plan (if applicable);
3. Construction (Partition) Plan;
4. Power/Communication (Electrical) Plan;
5. Furniture Plan; and
6. Finish Plan.

C. Government review and approval of Lessor-provided DIDs: The Government must notify the Lessor of DID approval not later than ten (10) Working Days following submission of DIDs conforming to the requirements of this Lease as supplied by the Government. Should the DIDs not conform to these requirements, the Government must notify the Lessor of such non-conformances within the same period; however, the Lessor shall be

responsible for any delay to approval of DID's occasioned by such non-conformance. The Government's review and approval of the DID's is limited to conformance to the specific requirements of the Lease as they apply to the Space.

D. The Lessor's preparation and submission of construction documents (CDs): The Lessor as part of the TI must complete CDs conforming to the approved DID's not later than fifteen (15) Working Days following the approval of DID's. If during the preparation of CDs the Lessor becomes aware that any material requirement indicated in the approved DID's cannot be reasonably achieved, the Lessor shall promptly notify CBP, and shall not proceed with completion of CDs until direction is received from the LCO. The LCO shall provide direction within five (5) Working Days of such notice, but the Government shall not be responsible for delays to completion of CDs occasioned by such circumstances. For the purpose of this paragraph, a "material requirement" shall mean any requirement necessary for the Government's intended use of the Space as provided for in, or reasonably inferable from, the Lease and the approved DID's (e.g., number of workstations and required adjacencies).

E. Government review of CDs: The Government shall have ten (10) Working Days to review CDs prior to issuing a Notice to Proceed (NTP). At any time during this period of review, the Government shall have the right to require the Lessor to modify the CDs to enforce conformance to Lease requirements and the approved DID's.

F. Construction of TIs and completion of other required construction work: The Lessor shall complete all work required to prepare the Premises as required in this Lease ready for use not later than one hundred and twenty (120) Working days following issuance of NTP.

5.12 CONSTRUCTION DOCUMENTS (SEP 2012)

The Lessor's CDs shall include all mechanical, electrical, plumbing, fire protection, life safety, lighting, structural, security, and architectural improvements scheduled for inclusion into the Space. CDs shall be annotated with all applicable specifications. CDs shall also clearly identify TIs already in place and the work to be done by the Lessor or others. Notwithstanding the Government's review of the CDs, the Lessor is solely responsible and liable for their technical accuracy and compliance with all applicable Lease requirements.

5.13 RESPONSIBILITY OF THE LESSOR AND LESSOR'S ARCHITECT/ENGINEER (JUN 2012)

A. The Lessor shall be responsible for the professional quality, technical accuracy, and the coordination of all designs, drawings, specifications, and other services furnished by the Lessor under this contract. The Lessor shall, without additional compensation, correct or revise any errors or deficiencies in its designs, drawings, specifications, or other services.

B. The Lessor remains solely responsible for designing, constructing, operating, and maintaining the leased premises in full accordance with the requirements of the Lease. The Government retains the right to review and approve many aspects of the Lessor's design, including without limitation, review of the Lessor's design and construction drawings, shop drawings, product data, finish samples, and completed base building and TI construction. Such review and approval is intended to identify potential design flaws, to minimize costly misdirection of effort, and to assist the Lessor in its effort to monitor whether such design and construction comply with applicable laws and satisfy all Lease requirements.

C. Neither the Government's review, approval or acceptance of, nor payment through rent of the services required under this contract, shall be construed to operate as a waiver of any rights under this contract or of any cause of action arising out of the performance of this contract, and the Lessor shall be and remain liable to the Government in accordance with applicable law for all damages to the Government caused by the Lessor's negligent performance of any of the services required under this Lease.

D. Design and construction and performance information is contained throughout several of the documents which comprise this Lease. The Lessor shall provide to space planners, architects, engineers, construction contractors, etc., all information required whether it is found in this Lease, special requirements and attachments, price lists, or design intent drawings. Reliance upon one of these documents to the exclusion of any other may result in an incomplete understanding of the scope of the work to be performed and/or services to be provided.

5.14 CONSTRUCTION SCHEDULE AND INITIAL CONSTRUCTION MEETING (OCT 2020)

The Lessor shall furnish a detailed construction schedule (such as Critical Path Method) to the Government within ten (10) Working Days of issuance of the NTP. Such schedule shall also indicate the dates available for Government contractors to install telephone/data lines or equipment, if needed. Within ten (10) Working Days of NTP, the Lessor shall initiate a construction meeting. This meeting may be held in person or virtually, at the discretion of the Government. The Lessor will have contractor representatives including its architects, engineers, general contractor and sub-contractor representatives in attendance. The Lessor shall keep meeting minutes of discussion topics and attendance.

5.15 PROGRESS REPORTS (OCT 2020)

After start of construction, the Lessor shall submit to the COR written progress reports. These updates shall be transmitted via email by 4:00 PM (Local Time) each Friday. Each report shall include information as to the percentage of the work completed by phase and trade; a statement as to expected completion and occupancy dates; changes introduced into the work; and general remarks on such items as material shortages, strikes, weather, etc, that may affect timely completion. In addition, at the Government's discretion, the Lessor shall conduct meetings every two weeks to brief Government personnel and/or contractors regarding the progress of design and construction of the Space. These meetings may be held in person or virtually, at the discretion of the Government. The Lessor or its designee shall be responsible for taking and distributing minutes of these meetings.

5.16 CONSTRUCTION INSPECTIONS (SEP 2015)

A. The LCO or the LCO's designated technical representative may periodically inspect construction work to review compliance with Lease requirements and approved DID's, if applicable.

B. Periodic reviews, witnessing of tests, and inspections by the Government shall not constitute approval of the Lessor's apparent progress toward meeting the Government's objectives but are intended to discover any information which the LCO may be able to call to the Lessor's attention to

prevent costly misdirection of effort. The Lessor shall remain responsible for designing, constructing, operating, and maintaining the Building in full accordance with the requirements of the Lease.

5.17 ACCESS BY THE GOVERNMENT PRIOR TO ACCEPTANCE (SEP 2013)

The Government shall have the right to access any space within the Building during construction for the purposes of performing inspections or installing Government furnished equipment. The Government shall coordinate the activity of Government contractors with the Lessor to minimize conflicts with and disruption to other contractors on site. Access shall not be unreasonably denied to authorized Government officials including, but not limited to, Government contractors, subcontractors, or consultants acting on behalf of the Government on this project.

5.18 ACCEPTANCE OF SPACE AND CERTIFICATE OF OCCUPANCY (OCT 2021)

A. Ten (10) Working Days prior to the completion of the Space, the Lessor shall issue written notice to the Government to schedule the inspection of the Space for acceptance. The Government shall accept the Space only if the construction of Building shell and TIs conforming to this Lease and the approved DIDs, if applicable, is substantially complete, a Certificate of Occupancy (C of O) has been issued as set forth below, and the Building improvements necessary for acceptance as described in the paragraph "Building Improvements" are completed.

B. The Space shall be considered substantially complete only if the Space may be used for its intended purpose, and completion of remaining work will not interfere unreasonably with the Government's enjoyment of the Space. Acceptance shall be final and binding upon the Government with respect to conformance of the completed TIs to the approved DIDs, with the exception of items identified on a punch list generated as a result of the inspection, concealed conditions, latent defects, or fraud, but shall not relieve the Lessor of any other Lease requirements.

C. The Lessor shall provide a valid C of O, issued by the local jurisdiction, for the intended use of the Government. If the local jurisdiction does not issue C of O's or if the C of O is not available, the Lessor may satisfy this condition by providing a report prepared by a licensed fire protection engineer that indicates the Space and Building are compliant with all applicable local codes and ordinances and all fire protection and life safety-related requirements of this Lease.

D. The Government will not be required to accept space prior to the schedule outlined in this Lease.

5.19 LEASE TERM COMMENCEMENT DATE AND RENT RECONCILIATION (OCT 2021)

At acceptance, the Space shall be measured in accordance with the standards set forth in this Lease to determine the total ABOA SF in the Space. The rent for the Space will be adjusted based upon the measured ABOA square footage as outlined under the Payment clause of the General Clauses. At acceptance, the Lease term shall commence. The Lease Term Commencement Date, final measurement of the Space, reconciliation of the annual rent, and amount of Commission Credit, if any, shall be memorialized by Lease Amendment.

5.20 AS-BUILT DRAWINGS (OCT 2021)

Not later than thirty (30) days after the acceptance of the Space, the Lessor, at Lessor's expense, shall furnish to the Government a complete set of Computer Aided Design (CAD) files of as-built floor plans showing the Space under Lease, as well as corridors, stairways, and core areas. As-built drawings shall include those for Civil, Architectural, Mechanical, Electrical, and Plumbing features, including, but not limited to, those for IT, Communications, Security, and Fire Protection. The plans shall have been generated by a CAD program which is compatible with the latest release of AutoCAD. The required file extension is ".DWG." Clean and purged files shall be submitted in a digital format. They shall be labeled with Building name, address, list of drawing(s), date of the drawing(s), and Lessor's architect and architect's phone number.

5.21 LESSOR'S PROJECT MANAGEMENT RESPONSIBILITIES (OCT 2020)

The Lessor's project management costs associated with the delivery of Tenant Improvements, including, but not limited to:

1. Legal fees
2. Travel costs
3. Insurance
4. Home office overhead and other indirect costs
5. Carrying costs, exclusive of the TI amortization rate. Carrying costs are those costs of capital incurred for the delivery of TI, for the period starting from Lessor's outlay of funds, until the Lease Term Commencement Date.
6. Construction permits associated with TI build-out.
7. TI proposal preparation costs
8. Lessor's labor costs related to the management of the TI build-out.

B. At a minimum, the Lessor shall be responsible for performing the following services:

1. Provide assistance and expertise to the Government project team in the form of coordination, management, and administration of the design and construction process;
2. Monitor performance of the general contractor and other contractors, control schedules, and oversee financial accounts;
3. Conduct and document design and construction project meetings;
4. Perform administrative tasks, including documentation, record keeping (issuing meeting minutes), and payment validation in addition to submittal and change order processing;
5. Maintain Request for Information (RFI), submittal, and change order logs; and
6. Provide technical expertise (e.g. testing, estimating, resolving claims, or responding to inquiries).

5.22 TENANT IMPROVEMENT REQUIREMENTS (OCT 2016)

The TIs shall be designed, constructed, and maintained in accordance with the standards set forth in this Lease. For pricing, only those requirements designated as TIs within the attached agency requirements, shall be deemed to be TI costs.

5.23 FINISH SELECTIONS (SMALL) (SEP 2015)

The Lessor must consult with the Government prior to developing a minimum of three (3) options of coordinated finish samples. The finish options must be approved by CBP prior to installation. The Lessor may not make any substitutions.

5.24 WINDOW COVERINGS (SMALL) (OCT 2020)

All exterior windows shall be equipped with window blinds in new or like new condition, as approved by the Government.

5.25 DOORS: INTERIOR (SLAT) (OCT 2020)

A. Doors within the Space shall be provided as part of the TIs and shall have a minimum clear opening of 32" wide x 80" high. Doors shall be flush, solid core, wood with a natural wood veneer face or an equivalent door pre-approved by the LCO. Hollow core wood doors are not acceptable. They shall be operable with a single effort, and shall meet the requirements of NFPA 101, Life Safety Code or the International Building Code (current as of the Lease Award Date). Doors shall be installed in a metal frame assembly which is primed and finished with a low VOC semi-gloss oil-based paint and which does not result in indoor air quality levels above 0.016 parts per million (ppm) of formaldehyde.

5.26 DOORS: HARDWARE (SEP 2013)

Doors shall have door handles or door pulls with heavyweight hinges. The Lessor is encouraged to avoid the use of chrome-plated hardware. All doors shall have corresponding doorstops (wall- or floor-mounted) and silencers. All door entrances leading into the Space from public corridors and exterior doors shall have automatic door closers. Doors designated by the Government shall be equipped with 5-pin, tumbler cylinder locks and strike plates. All locks shall be master keyed. Furnish at least two master keys for each lock to the Government. Any exterior entrance shall have a high security lock, with appropriate key control procedures, as determined by Government specifications. Hinge pins and hasps shall be secured against unauthorized removal by using spot welds or pinned mounting bolts. The exterior side of the door shall have a lock guard or astragal to prevent tampering of the latch hardware. Doors used for egress only shall not have any operable exterior hardware. All security-locking arrangements on doors used for egress shall comply with requirements of NFPA 101 or the International Building Code current as of the Lease Award Date.

5.27 DOORS: IDENTIFICATION (JUN 2012)

Door identification shall be installed in approved locations adjacent to office entrances as part of the TIs. The form of door identification shall be approved by the Government.

5.28 ~~PARTITIONS: SUBDIVIDING (SLAT) (OCT 2020)~~ INTENTIONALLY DELETED

5.29 PAINTING – TI (SMALL) (OCT 2020)

A. Prior to acceptance, all surfaces within the Space which are designated by CBP for painting shall be newly finished in colors and type of paint acceptable to the Government.

5.30 FLOOR COVERINGS AND PERIMETERS (SMALL) (OCT 2019)

A. Unless otherwise specified, broadloom carpet or carpet tiles shall be installed in accordance with manufacturing instructions to lay smoothly and evenly throughout the Space. Floor perimeters at partitions shall have wood, rubber, vinyl, or carpet base.

B. The use of existing carpet may be approved by the Government; however, existing carpet shall be repaired, stretched, and cleaned before occupancy and shall meet the static buildup requirement as stated in the specifications below.

C. Any alternate flooring shall be pre-approved by the Government.

D. SPECIFICATIONS FOR CARPET TO BE NEWLY INSTALLED OR REPLACED

1. Performance requirements for broadloom and modular tile.
 - a. Static: Less than or equal to 3.5 kV when tested by AATCC Test Method 134 (Step Test Option).
 - b. Flammability: Meets CPSC-FF-1-70, DOC-FF-1-70 Methenamine Tablet Test criteria.
 - c. Flooring Radiant Panel Test: Meets NFPA 253 Class I or II depending upon occupancy and fire code when tested under ASTM E-648 for glue down installation.
 - d. Smoke Density: NBS Smoke Chamber - Less than 450 Flaming Mode when tested under ASTM E-662.

2. Texture Appearance Retention Rating (TARR). Moderate; ≥ 3.0 TARR.

5.31 TELECOMMUNICATIONS: DISTRIBUTION AND EQUIPMENT (JUN 2012)

Telecommunications floor or wall outlets shall be provided as part of the TIs. At a minimum, each outlet shall house one 4-pair wire jack for voice and one 4-pair wire jack for data. The Lessor shall ensure that all outlets and associated wiring, copper, coaxial cable, optical fiber, or other transmission medium used to transmit telecommunications (voice, data, video, Internet, or other emerging technologies) service to the workstation shall be safely concealed under raised floors, in floor ducts, walls, columns, or molding. All outlets/junction boxes shall be provided with rings and pull strings to facilitate the installation of cable. Some transmission medium may require special conduit, inner duct, or shielding as specified by the Government.

5.32 DATA DISTRIBUTION (OCT 2020)

The Lessor shall purchase and install data cable as part of the tenant improvements. The Lessor shall safely conceal data outlets and the associated wiring used to transmit data to workstations in floor ducts, walls, columns, or below access flooring. When cable consists of multiple runs, the Lessor shall provide ladder type or other acceptable cable trays to prevent cable coming into contact with suspended ceilings or sprinkler piping. Cable trays shall form a loop around the perimeter of the Space such that they are within a 30-foot horizontal distance of any single drop. If the Government chooses to purchase and install data cabling, then the Lessor shall provide, as part of the tenant improvements, outlets with rings and pull strings to facilitate the installation of the data cable.

5.33 ELECTRICAL, TELEPHONE, DATA FOR SYSTEMS FURNITURE (OCT 2020)

A. The Lessor shall provide as part of the TIs separate data, telephone, and electric junction boxes for the base feed connections to Government provided modular or systems furniture, when such feeds are supplied via wall outlets or floor penetrations. When overhead feeds are used, junction boxes shall be installed for electrical connections. Raceways shall be provided throughout the furniture panels to distribute the electrical, telephone, and data cable. The Lessor shall provide all electrical service wiring and connections to the furniture at designated junction points. Each electrical junction shall contain an 8-wire feed consisting of 3 general purpose 120-V circuits with 1 neutral and 1 ground wire, and a 120-V isolated ground circuit with 1 neutral and 1 isolated ground wire. A 20-ampere circuit shall have no more than 8 general purpose receptacles or 4 isolated ground "computer" receptacles.

B. The Lessor shall purchase and install data and telecommunications cable. Said cable shall be installed and connected to systems furniture by the Lessor/contractor with the assistance and/or advice of the Government or computer vendor. The Lessor shall provide wall mounted data and telephone junction boxes. When cable consists of multiple runs, the Lessor shall provide ladder-type or other acceptable cable trays to prevent Government provided cable coming into contact with suspended ceilings or sprinkler piping. Cable trays shall form a loop around the perimeter of the Space such that they are within a 30-foot horizontal distance of any single drop. Said cable trays shall provide access to both telecommunications data closets and telephone closets. If the Government chooses to purchase and install data and telecommunications cabling, then the Lessor shall provide, as part of the TIs, outlets with rings and pull strings to facilitate the installation of the data cable.

C. The Lessor shall furnish and install suitably sized junction boxes near the "feeding points" of the furniture panels. All "feeding points" shall be shown on Government approved design intent drawings. The Lessor shall temporarily cap off the wiring in the junction boxes until the furniture is installed. The Lessor shall make all connections in the power panel and shall keep the circuit breakers off. The Lessor shall identify each circuit with the breaker number and shall identify the computer hardware to be connected to it. The Lessor shall identify each breaker at the panel and identify the devices that it serves.

D. The Lessor's electrical contractor must connect power poles or base feeds in the junction boxes to the furniture electrical system and test all pre-wired receptacles in the systems furniture. Other Government contractors will be installing the data cable in the furniture panels for the terminal and printer locations, installing the connectors on the terminal/printer ends of the cable, and continuity testing each cable. Work shall be coordinated and performed in conjunction with the furniture, telephone, and data cable installers. Much of this work may occur over a weekend on a schedule that requires flexibility and on-call visits. The Lessor must coordinate the application of Certification of Occupancy with furniture installation.

5.34 SECURITY REQUIREMENTS (OCT 2021)

The Lessor agrees to allow the Government install the requirements of Facility Security Level 111 as part of the Statement of Work.

5.35 OWNERSHIP

The Lessor represents and warrants that it is the fee simple owner of the property that is the subject of this Lease and has the right to enter into this Lease and to grant the Government exclusive access to the premises and all the rights set forth herein. Lessor warrants that no third party has superior or conflicting rights.

5.36 NO WAIVER OF SOVEREIGN IMMUNITY

Nothing herein shall require the Government to perform any act, or to not act (i.e., an omission), in a manner that would constitute a violation of law or federal fiscal policy. Nothing herein shall be construed as a waiver of the sovereign immunity of the United States.

5.37 LEASE EXPIRATION

At the expiration of the lease term, inclusive of any option exercised by the Government, a new lease agreement must be negotiated and executed prior to the expiration date, or the Government will vacate the premises at the end of the Lease term.

5.38 NO THIRD PARTY BENEFICIARY

The parties agree that this Lease is not intended and should not be construed to create any right or benefit, substantive or procedural, enforceable at law by an outside party against either the Lessor or the Government.

5.39 FAA PROVISIONS

To the extent consistent with applicable law and to the extent applicable to CBP as a federal government agency, CBP agrees to comply with the Addendum language. "See *Exhibit K*".

5.40 MODIFIED LEASE PARAGRAPHS (OCT 2016)

The following paragraphs have been modified in this Lease:

- 1.03 RENT AND OTHER CONSIDERATION (ON-AIRPORT) (OCT 2021)
- 1.07 OPERATING COST BASE (OCT 2016)
- 4.01 SERVICES, UTILITIES, AND MAINTENANCE (ON-AIRPORT) (OCT 2020)

GENERAL CLAUSES
(Acquisition of Leasehold Interests in Real Property)

CATEGORY	CLAUSE NO.	48 CFR REF.	CLAUSE TITLE
GENERAL	1		SUBLETTING AND ASSIGNMENT
	2	552.270-11	SUCCESSORS BOUND
	3	552.270-23	SUBORDINATION, NON-DISTURBANCE AND ATTORNMEN
	4	552.270-24	STATEMENT OF LEASE
	5	552.270-25	SUBSTITUTION OF TENANT AGENCY
	6	552.270-26	NO WAIVER
	7		INTEGRATED AGREEMENT
	8	552.270-28	MUTUALITY OF OBLIGATION
PERFORMANCE	9		DELIVERY AND CONDITION
	10		DEFAULT BY LESSOR
	11	552.270-19	PROGRESSIVE OCCUPANCY
	12		MAINTENANCE OF THE PROPERTY, RIGHT TO INSPECT
	13		FIRE AND CASUALTY DAMAGE
	14		COMPLIANCE WITH APPLICABLE LAW
	15	552.270-12	ALTERATIONS
	16		ACCEPTANCE OF SPACE AND CERTIFICATE OF OCCUPANCY
PAYMENT	17	52.204-13	SYSTEM FOR AWARD MANAGEMENT MAINTENANCE
	18	552.270-31	PROMPT PAYMENT
	19	52.232-23	ASSIGNMENT OF CLAIMS
	20		PAYMENT
	21	52.232-33	PAYMENT BY ELECTRONIC FUNDS TRANSFER—SYSTEM FOR AWARD MANAGEMENT
STANDARDS OF CONDUCT	22	52.203-13	CONTRACTOR CODE OF BUSINESS ETHICS AND CONDUCT
	23	552.270-32	COVENANT AGAINST CONTINGENT FEES
	24	52-203-7	ANTI-KICKBACK PROCEDURES
	25	52-223-6	DRUG-FREE WORKPLACE
	26	52.203-14	DISPLAY OF HOTLINE POSTER(S)
ADJUSTMENTS	27	552.270-30	PRICE ADJUSTMENT FOR ILLEGAL OR IMPROPER ACTIVITY
	28	52.215-10	PRICE REDUCTION FOR DEFECTIVE COST OR PRICING DATA
	29	552.270-13	PROPOSALS FOR ADJUSTMENT
	30		CHANGES
AUDITS	31	552.215-70	EXAMINATION OF RECORDS BY GSA
	32	52.215-2	AUDIT AND RECORDS—NEGOTIATION
DISPUTES	33	52.233-1	DISPUTES

LESSOR: _____ GOVERNMENT: _____

LABOR STANDARDS	34	52.222-26	EQUAL OPPORTUNITY
	35	52.222-21	PROHIBITION OF SEGREGATED FACILITIES
	36	52.219-28	POST-AWARD SMALL BUSINESS PROGRAM REREPRESENTATION
	37	52.222-35	EQUAL OPPORTUNITY FOR VETERANS
	38	52.222-36	EQUAL OPPORTUNITY FOR WORKERS WITH DISABILITIES
	39	52.222-37	EMPLOYMENT REPORTS ON VETERANS
SUBCONTRACTING	40	52.209-6	PROTECTING THE GOVERNMENT'S INTEREST WHEN SUBCONTRACTING WITH CONTRACTORS DEBARRED, SUSPENDED, OR PROPOSED FOR DEBARMENT
	41	52.215-12	SUBCONTRACTOR CERTIFIED COST OR PRICING DATA
	42	52.219-8	UTILIZATION OF SMALL BUSINESS CONCERNS
	43	52.219-9	SMALL BUSINESS SUBCONTRACTING PLAN
	44	52.219-16	LIQUIDATED DAMAGES—SUBCONTRACTING PLAN
	45	52.204-10	REPORTING EXECUTIVE COMPENSATION AND FIRST- TIER SUBCONTRACT AWARDS
OTHER	46	52.204-25	PROHIBITION ON CONTRACTING FOR CERTAIN TELECOMMUNICATIONS AND VIDEO SURVEILLANCE SERVICES OR EQUIPMENT
	47		INTENTIONALLY DELETED
	48	52.204-19	INCORPORATION BY REFERENCE OF REPRESENTATIONS AND CERTIFICATIONS

The information collection requirements contained in this solicitation/contract that are not required by regulation have been approved by the Office of Management and Budget (OMB) pursuant to the Paperwork Reduction Act and assigned the OMB Control No. 3090-0163.

LESSOR: _____ GOVERNMENT: _____

GENERAL CLAUSES
(Acquisition of Leasehold Interests in Real Property)

1. SUBLETTING AND ASSIGNMENT (JAN 2011)

The Government may sublet any part of the premises but shall not be relieved from any obligations under this lease by reason of any such subletting. The Government may at any time assign this lease, and be relieved from all obligations to Lessor under this lease excepting only unpaid rent and other liabilities, if any, that have accrued to the date of said assignment. Any subletting or assignment shall be subject to prior written consent of Lessor, which shall not be unreasonably withheld.

2. 552.270-11 SUCCESSORS BOUND (SEP 1999)

This lease shall bind, and inure to the benefit of, the parties and their respective heirs, executors, administrators, successors, and assigns.

3. 552.270-23 SUBORDINATION, NON-DISTURBANCE AND ATTORNMENT (SEP 1999)

(a) Lessor warrants that it holds such title to or other interest in the premises and other property as is necessary to the Government's access to the premises and full use and enjoyment thereof in accordance with the provisions of this lease. Government agrees, in consideration of the warranties and conditions set forth in this clause, that this lease is subject and subordinate to any and all recorded mortgages, deeds of trust and other liens now or hereafter existing or imposed upon the premises, and to any renewal, modification or extension thereof. It is the intention of the parties that this provision shall be self-operative and that no further instrument shall be required to effect the present or subsequent subordination of this lease. Government agrees, however, within twenty (20) business days next following the Contracting Officer's receipt of a written demand, to execute such instruments as Lessor may reasonably request to evidence further the subordination of this lease to any existing or future mortgage, deed of trust or other security interest pertaining to the premises, and to any water, sewer or access easement necessary or desirable to serve the premises or adjoining property owned in whole or in part by Lessor if such easement does not interfere with the full enjoyment of any right granted the Government under this lease.

(b) No such subordination, to either existing or future mortgages, deeds of trust or other lien or security instrument shall operate to affect adversely any right of the Government under this lease so long as the Government is not in default under this lease. Lessor will include in any future mortgage, deed of trust or other security instrument to which this lease becomes subordinate, or in a separate non-disturbance agreement, a provision to the foregoing effect. Lessor warrants that the holders of all notes or other obligations secured by existing mortgages, deeds of trust or other security instruments have consented to the provisions of this clause, and agrees to provide true copies of all such consents to the Contracting Officer promptly upon demand.

(c) In the event of any sale of the premises or any portion thereof by foreclosure of the lien of any such mortgage, deed of trust or other security instrument, or the giving of a deed in lieu of foreclosure, the Government will be deemed to have attorned to any purchaser, purchasers, transferee or transferees of the premises or any portion thereof and its or their successors and assigns, and any such purchasers and transferees will be deemed to have assumed all obligations of the Lessor under this lease, so as to establish direct privity of estate and contract between Government and such purchasers or transferees, with the same force, effect and relative priority in time and right as if the lease had initially been entered into between such purchasers or transferees and the Government; provided, further, that the Contracting Officer and such purchasers or transferees shall, with reasonable promptness following any such sale or deed delivery in lieu of foreclosure, execute all such revisions to this lease, or other writings, as shall be necessary to document the foregoing relationship.

(d) None of the foregoing provisions may be deemed or construed to imply a waiver of the Government's rights as a sovereign.

LESSOR: _____ GOVERNMENT: _____

4. 552.270-24 STATEMENT OF LEASE (SEP 1999)

(a) The Contracting Officer will, within thirty (30) days next following the Contracting Officer's receipt of a joint written request from Lessor and a prospective lender or purchaser of the building, execute and deliver to Lessor a letter stating that the same is issued subject to the conditions stated in this clause and, if such is the case, that (1) the lease is in full force and effect; (2) the date to which the rent and other charges have been paid in advance, if any; and (3) whether any notice of default has been issued.

(b) Letters issued pursuant to this clause are subject to the following conditions:

(1) That they are based solely upon a reasonably diligent review of the Contracting Officer's lease file as of the date of issuance;

(2) That the Government shall not be held liable because of any defect in or condition of the premises or building;

(3) That the Contracting Officer does not warrant or represent that the premises or building comply with applicable Federal, State and local law; and

(4) That the Lessor, and each prospective lender and purchaser are deemed to have constructive notice of such facts as would be ascertainable by reasonable pre-purchase and pre-commitment inspection of the Premises and Building and by inquiry to appropriate Federal, State and local Government officials.

5. 552.270-25 SUBSTITUTION OF TENANT AGENCY (SEP 1999)

The Government may, at any time and from time to time, substitute any Government agency or agencies for the Government agency or agencies, if any, named in the lease.

6. 552.270-26 NO WAIVER (SEP 1999)

No failure by either party to insist upon the strict performance of any provision of this lease or to exercise any right or remedy consequent upon a breach thereof, and no acceptance of full or partial rent or other performance by either party during the continuance of any such breach shall constitute a waiver of any such breach of such provision.

7. INTEGRATED AGREEMENT (JUN 2012)

This Lease, upon execution, contains the entire agreement of the parties and no prior written or oral agreement, express or implied, shall be admissible to contradict the provisions of the Lease. Except as expressly attached to and made a part of the Lease, neither the Request for Lease Proposals nor any pre-award communications by either party shall be incorporated in the Lease.

8. 552.270-28 MUTUALITY OF OBLIGATION (SEP 1999)

The obligations and covenants of the Lessor, and the Government's obligation to pay rent and other Government obligations and covenants, arising under or related to this Lease, are interdependent. The Government may, upon issuance of and delivery to Lessor of a final decision asserting a claim against Lessor, set off such claim, in whole or in part, as against any payment or payments then or thereafter due the Lessor under this lease. No setoff pursuant to this clause shall constitute a breach by the Government of this lease.

9. DELIVERY AND CONDITION (JAN 2011)

(a) Unless the Government elects to have the space occupied in increments, the space must be delivered ready for occupancy as a complete unit.

(b) The Government may elect to accept the Space notwithstanding the Lessor's failure to deliver the Space substantially complete; if the Government so elects, it may reduce the rent payments.

LESSOR: _____ GOVERNMENT: _____

10. DEFAULT BY LESSOR (APR 2012)

(a) The following conditions shall constitute default by the Lessor, and shall give rise to the following rights and remedies for the Government:

(1) Prior to Acceptance of the Premises. Failure by the Lessor to diligently perform all obligations required for Acceptance of the Space within the times specified, without excuse, shall constitute a default by the Lessor. Subject to provision of notice of default to the Lessor, and provision of a reasonable opportunity for the Lessor to cure its default, the Government may terminate the Lease on account of the Lessor's default.

(2) After Acceptance of the Premises. Failure by the Lessor to perform any service, to provide any item, or satisfy any requirement of this Lease, without excuse, shall constitute a default by the Lessor. Subject to provision of notice of default to the Lessor, and provision of a reasonable opportunity for the Lessor to cure its default, the Government may perform the service, provide the item, or obtain satisfaction of the requirement by its own employees or contractors. If the Government elects to take such action, the Government may deduct from rental payments its costs incurred in connection with taking the action. Alternatively, the Government may reduce the rent by an amount reasonably calculated to approximate the cost or value of the service not performed, item not provided, or requirement not satisfied, such reduction effective as of the date of the commencement of the default condition.

(3) Grounds for Termination. The Government may terminate the Lease if:

(i) The Lessor's default persists notwithstanding provision of notice and reasonable opportunity to cure by the Government, or

(ii) The Lessor fails to take such actions as are necessary to prevent the recurrence of default conditions,

and such conditions (i) or (ii) substantially impair the safe and healthful occupancy of the Premises, or render the Space unusable for its intended purposes.

(4) Excuse. Failure by the Lessor to timely deliver the Space or perform any service, provide any item, or satisfy any requirement of this Lease shall not be excused if its failure in performance arises from:

(i) Circumstances within the Lessor's control;

(ii) Circumstances about which the Lessor had actual or constructive knowledge prior to the Lease Award Date that could reasonably be expected to affect the Lessor's capability to perform, regardless of the Government's knowledge of such matters;

(iii) The condition of the Property;

(iv) The acts or omissions of the Lessor, its employees, agents or contractors; or

(v) The Lessor's inability to obtain sufficient financial resources to perform its obligations.

(5) The rights and remedies specified in this clause are in addition to any and all remedies to which the Government may be entitled as a matter of law.

11. 552.270-19 PROGRESSIVE OCCUPANCY (SEP 1999)

The Government shall have the right to elect to occupy the space in partial increments prior to the substantial completion of the entire leased premises, and the Lessor agrees to schedule its work so as to deliver the space incrementally as elected by the Government. The Government shall pay rent commencing with the first business day following substantial completion of the entire leased premise unless the Government has elected to occupy the leased premises incrementally. In case of incremental occupancy, the Government shall pay rent pro rata upon the first business day following substantial

LESSOR: _____ GOVERNMENT: _____

completion of each incremental unit. Rental payments shall become due on the first workday of the month following the month in which an increment of space is substantially complete, except that should an increment of space be substantially completed after the fifteenth day of the month, the payment due date will be the first workday of the second month following the month in which it was substantially complete. The commencement date of the firm lease term will be a composite determined from all rent commencement dates.

12. MAINTENANCE OF THE PROPERTY, RIGHT TO INSPECT (APR 2015)

The Lessor shall maintain the Property, including the building, building systems, and all equipment, fixtures, and appurtenances furnished by the Lessor under this Lease, in good repair and tenantable condition so that they are suitable in appearance and capable of supplying such heat, air conditioning, light, ventilation, safety systems, access and other things to the premises, without reasonably preventable or recurring disruption, as is required for the Government's access to, occupancy, possession, use and enjoyment of the premises as provided in this lease. For the purpose of so maintaining the premises, the Lessor may at reasonable times enter the premises with the approval of the authorized Government representative in charge. Upon request of the Lease Contracting Officer (LCO), the Lessor shall provide written documentation that building systems have been properly maintained, tested, and are operational within manufacturer's warranted operating standards. The Lessor shall maintain the Premises in a safe and healthful condition according to applicable OSHA standards and all other requirements of this Lease, including standards governing indoor air quality, existence of mold and other biological hazards, presence of hazardous materials, etc. The Government shall have the right, at any time after the Lease Award Date and during the term of the Lease, to inspect all areas of the Property to which access is necessary for the purpose of determining the Lessor's compliance with this clause.

13. FIRE AND CASUALTY DAMAGE (JUN 2016)

If the building in which the Premises are located is totally destroyed or damaged by fire or other casualty, this Lease shall immediately terminate. If the building in which the Premises are located are only partially destroyed or damaged, so as to render the Premises untenable, or not usable for their intended purpose, the Lessor shall have the option to elect to repair and restore the Premises or terminate the Lease. The Lessor shall be permitted a reasonable amount of time, not to exceed **270 days** from the event of destruction or damage, to repair or restore the Premises, provided that the Lessor submits to the Government a reasonable schedule for repair of the Premises within **60 days** of the event of destruction or damage. If the Lessor fails to timely submit a reasonable schedule for completing the work, the Government may elect to terminate the Lease effective as of the date of the event of destruction or damage. If the Lessor elects to repair or restore the Premises, but fails to repair or restore the Premises within **270 days** from the event of destruction or damage, or fails to diligently pursue such repairs or restoration so as to render timely completion commercially impracticable, the Government may terminate the Lease effective as of the date of the destruction or damage. During the time that the Premises are unoccupied, rent shall be abated. Termination of the Lease by either party under this clause shall not give rise to liability for either party.

Nothing in this lease shall be construed as relieving Lessor from liability for damage to, or destruction of, property of the United States of America caused by the willful or negligent act or omission of Lessor.

14. COMPLIANCE WITH APPLICABLE LAW (JAN 2011)

Lessor shall comply with all Federal, state and local laws applicable to its ownership and leasing of the Property, including, without limitation, laws applicable to the construction, ownership, alteration or operation of all buildings, structures, and facilities located thereon, and obtain all necessary permits, licenses and similar items at its own expense. The Government will comply with all Federal, State and local laws applicable to and enforceable against it as a tenant under this lease, provided that nothing in this Lease shall be construed as a waiver of the sovereign immunity of the Government. This Lease shall be governed by Federal law.

15. 552.270-12 ALTERATIONS (SEP 1999)

The Government shall have the right during the existence of this lease to make alterations, attach fixtures, and erect structures or signs in or upon the premises hereby leased, which fixtures, additions or structures so placed in, on, upon, or attached to the said premises shall be and remain the property of the Government and may be removed or otherwise disposed of by the Government. If the lease contemplates that the Government is the sole occupant of the building, for

LESSOR: _____ GOVERNMENT: _____

purposes of this clause, the leased premises include the land on which the building is sited and the building itself. Otherwise, the Government shall have the right to tie into or make any physical connection with any structure located on the property as is reasonably necessary for appropriate utilization of the leased space.

16. ACCEPTANCE OF SPACE AND CERTIFICATE OF OCCUPANCY (APR 2015)

(a) Ten (10) working days prior to the completion of the Space, the Lessor shall issue written notice to the Government to schedule the inspection of the Space for acceptance. The Government shall accept the Space only if the construction of building shell and TIs conforming to this Lease and the approved DIDs is substantially complete, and a Certificate of Occupancy has been issued as set forth below.

(b) The Space shall be considered substantially complete only if the Space may be used for its intended purpose and completion of remaining work will not unreasonably interfere with the Government's enjoyment of the Space. Acceptance shall be final and binding upon the Government with respect to conformance of the completed TIs to the approved DIDs, with the exception of items identified on a punchlist generated as a result of the inspection, concealed conditions, latent defects, or fraud, but shall not relieve the Lessor of any other Lease requirements.

(c) The Lessor shall provide a valid Certificate of Occupancy, issued by the local jurisdiction, for the intended use of the Government. If the local jurisdiction does not issue Certificates of Occupancy or if the Certificate of Occupancy is not available, the Lessor may satisfy this condition by providing a report prepared by a licensed fire protection engineer that indicates that the Space and Building are compliant with all applicable local codes and ordinances and all fire protection and life safety-related requirements of this Lease to ensure an acceptable level of safety is provided. Under such circumstances, the Government shall only accept the Space without a Certificate of Occupancy if a licensed fire protection engineer determines that the offered space is compliant with all applicable local codes and ordinances and fire protection and life safety-related requirements of this Lease.

17. 52.204-13 SYSTEM FOR AWARD MANAGEMENT MAINTENANCE (OCT 2018)

This clause is incorporated by reference.

18. 552.270-31 PROMPT PAYMENT (JUN 2011)

The Government will make payments under the terms and conditions specified in this clause. Payment shall be considered as being made on the day a check is dated or an electronic funds transfer is made. All days referred to in this clause are calendar days, unless otherwise specified.

(a) *Payment due date—*

(1) *Rental payments.* Rent shall be paid monthly in arrears and will be due on the first workday of each month, and only as provided for by the lease.

(i) When the date for commencement of rent falls on the 15th day of the month or earlier, the initial monthly rental payment under this contract shall become due on the first workday of the month following the month in which the commencement of the rent is effective.

(ii) When the date for commencement of rent falls after the 15th day of the month, the initial monthly rental payment under this contract shall become due on the first workday of the second month following the month in which the commencement of the rent is effective.

(2) *Other payments.* The due date for making payments other than rent shall be the later of the following two events:

(i) The 30th day after the designated billing office has received a proper invoice from the Contractor.

LESSOR: _____ GOVERNMENT: _____

(ii) The 30th day after Government acceptance of the work or service. However, if the designated billing office fails to annotate the invoice with the actual date of receipt, the invoice payment due date shall be deemed to be the 30th day after the Contractor's invoice is dated, provided a proper invoice is received and there is no disagreement over quantity, quality, or Contractor compliance with contract requirements.

(b) *Invoice and inspection requirements for payments other than rent.*

(1) The Contractor shall prepare and submit an invoice to the designated billing office after completion of the work. A proper invoice shall include the following items:

(i) Name and address of the Contractor.

(ii) Invoice date.

(iii) Lease number.

(iv) Government's order number or other authorization.

(v) Description, price, and quantity of work or services delivered.

(vi) Name and address of Contractor official to whom payment is to be sent (must be the same as that in the remittance address in the lease or the order).

(vii) Name (where practicable), title, phone number, and mailing address of person to be notified in the event of a defective invoice.

(2) The Government will inspect and determine the acceptability of the work performed or services delivered within seven days after the receipt of a proper invoice or notification of completion of the work or services unless a different period is specified at the time the order is placed. If actual acceptance occurs later, for the purpose of determining the payment due date and calculation of interest, acceptance will be deemed to occur on the last day of the seven day inspection period. If the work or service is rejected for failure to conform to the technical requirements of the contract, the seven days will be counted beginning with receipt of a new invoice or notification. In either case, the Contractor is not entitled to any payment or interest unless actual acceptance by the Government occurs.

(c) *Interest Penalty.*

(1) An interest penalty shall be paid automatically by the Government, without request from the Contractor, if payment is not made by the due date.

(2) The interest penalty shall be at the rate established by the Secretary of the Treasury under Section 12 of the Contract Disputes Act of 1978 (41 U.S.C. 611) that is in effect on the day after the due date. This rate is referred to as the "Renegotiation Board Interest Rate," and it is published in the **Federal Register** semiannually on or about January 1 and July 1. The interest penalty shall accrue daily on the payment amount approved by the Government and be compounded in 30-day increments inclusive from the first day after the due date through the payment date.

(3) Interest penalties will not continue to accrue after the filing of a claim for such penalties under the clause at 52.233-1, Disputes, or for more than one year. Interest penalties of less than \$1.00 need not be paid.

(4) Interest penalties are not required on payment delays due to disagreement between the Government and Contractor over the payment amount or other issues involving contract compliance or on amounts temporarily withheld or retained in accordance with the terms of the contract. Claims involving disputes, and any interest that may be payable, will be resolved in accordance with the clause at 52.233-1, Disputes.

(d) *Overpayments.* If the Lessor becomes aware of a duplicate payment or that the Government has otherwise overpaid on a payment, the Contractor shall—

LESSOR: _____ GOVERNMENT: _____

(1) Return the overpayment amount to the payment office cited in the contract along with a description of the overpayment including the—

(i) Circumstances of the overpayment (e.g., duplicate payment, erroneous payment, liquidation errors, date(s) of overpayment);

(ii) Affected lease number; (iii) Affected lease line item or sub-line item, if applicable; and

(iii) Lessor point of contact.

(2) Provide a copy of the remittance and supporting documentation to the Contracting Officer.

19. 52.232-23 ASSIGNMENT OF CLAIMS (MAY 2014)

(Applicable to leases over the micro-purchase threshold.)

(a) The Contractor, under the Assignment of Claims Act, as amended, [31 U.S.C. 3727](#), [41 U.S.C. 6305](#) (hereafter referred to as “the Act”), may assign its rights to be paid amounts due or to become due as a result of the performance of this contract to a bank, trust company, or other financing institution, including any Federal lending agency. The assignee under such an assignment may thereafter further assign or reassign its right under the original assignment to any type of financing institution described in the preceding sentence.

(b) Any assignment or reassignment authorized under the Act and this clause shall cover all unpaid amounts payable under this contract, and shall not be made to more than one party, except that an assignment or reassignment may be made to one party as agent or trustee for two or more parties participating in the financing of this contract.

(c) The Contractor shall not furnish or disclose to any assignee under this contract any classified document (including this contract) or information related to work under this contract until the Contracting Officer authorizes such action in writing.

20. PAYMENT (MAY 2011)

(a) When space is offered and accepted, the amount of American National Standards Institute/Building Owners and Managers Association Office Area (ABOA) square footage delivered will be confirmed by:

(1) The Government’s measurement of plans submitted by the successful Offeror as approved by the Government, and an inspection of the space to verify that the delivered space is in conformance with such plans or

(2) A mutual on-site measurement of the space, if the Contracting Officer determines that it is necessary.

(b) Payment will not be made for space which is in excess of the amount of ABOA square footage stated in the lease.

(c) If it is determined that the amount of ABOA square footage actually delivered is less than the amount agreed to in the lease, the lease will be modified to reflect the amount of ABOA space delivered and the annual rental will be adjusted as follows:

ABOA square feet not delivered multiplied by one plus the common area factor (CAF), multiplied by the rate per rentable square foot (RSF). That is: $(1+CAF) \times \text{Rate per RSF} = \text{Reduction in Annual Rent}$

21. 52.232-33 PAYMENT BY ELECTRONIC FUNDS TRANSFER—SYSTEM FOR AWARD MANAGEMENT (OCT 2018)

This clause is incorporated by reference.

LESSOR: _____ GOVERNMENT: _____

22. 52.203-13

Contractor Code of Business Ethics and Conduct (JUN 2020)

(Applicable to leases over \$5.5 million total contract value and performance period is 120 days or more.)

This clause is incorporated by reference.

23. 552.270-32

COVENANT AGAINST CONTINGENT FEES (JUN 2011)

(Applicable to leases over the Simplified Lease Acquisition Threshold.)

(a) The Contractor warrants that no person or agency has been employed or retained to solicit or obtain this contract upon an agreement or understanding for a contingent fee, except a bona fide employee or agency. For breach or violation of this warranty, the Government shall have the right to annul this contract without liability or, in its discretion, to deduct from the contract price or consideration, or otherwise recover the full amount of the contingent fee.

(b) *Bona fide agency*, as used in this clause, means an established commercial or selling agency (including licensed real estate agents or brokers), maintained by a Contractor for the purpose of securing business, that neither exerts nor proposes to exert improper influence to solicit or obtain Government contracts nor holds itself out as being able to obtain any Government contract or contracts through improper influence.

(1) *Bona fide employee*, as used in this clause, means a person, employed by a Contractor and subject to the Contractor's supervision and control as to time, place, and manner of performance, who neither exerts nor proposes to exert improper influence to solicit or obtain Government contracts nor holds out as being able to obtain any Government contract or contracts through improper influence.

(2) *Contingent fee*, as used in this clause, means any commission, percentage, brokerage, or other fee that is contingent upon the success that a person or concern has in securing a Government contract.

(3) *Improper influence*, as used in this clause, means any influence that induces or tends to induce a Government employee or officer to give consideration or to act regarding a Government contract on any basis other than the merits of the matter.

24. 52.203-7 ANTI-KICKBACK PROCEDURES (JUN 2020)

(Applicable to leases over the Simplified Lease Acquisition Threshold.)

This clause is incorporated by reference.

25. 52.223-6 DRUG-FREE WORKPLACE (MAY 2001)

(Applicable to leases over the Simplified Lease Acquisition Threshold, as well as to leases of any value awarded to an individual.)

This clause is incorporated by reference.

26. 52.203-14 DISPLAY OF HOTLINE POSTER(S) (JUN 2020)

(Applicable to leases over \$5.5 Million total contract value and performance period is 120 days or more.)

(a) *Definition.*

United States, as used in this clause, means the 50 States, the District of Columbia, and outlying areas.

(b) *Display of fraud hotline poster(s).* Except as provided in paragraph (c)—

LESSOR: _____ GOVERNMENT: _____

(1) During contract performance in the United States, the Contractor shall prominently display in common work areas within business segments performing work under this contract and at contract work sites-

(i) Any agency fraud hotline poster or Department of Homeland Security (DHS) fraud hotline poster identified in paragraph (b)(3) of this clause; and

(ii) Any DHS fraud hotline poster subsequently identified by the Contracting Officer.

(2) Additionally, if the Contractor maintains a company website as a method of providing information to employees, the Contractor shall display an electronic version of the poster(s) at the website.

(3) Any required posters may be obtained as follows:

Poster(s)	Obtain from
_____	_____
_____	_____

(Contracting Officer shall insert—

(i) Appropriate agency name(s) and/or title of applicable Department of Homeland Security fraud hotline poster); and

(ii) The website(s) or other contact information for obtaining the poster(s).)

(c) If the Contractor has implemented a business ethics and conduct awareness program, including a reporting mechanism, such as a hotline poster, then the Contractor need not display any agency fraud hotline posters as required in paragraph (b) of this clause, other than any required DHS posters.

(d) *Subcontracts.* The Contractor shall include the substance of this clause, including this paragraph (d), in all subcontracts that exceed the threshold specified in Federal Acquisition Regulation 3.1004(b)(1) on the date of subcontract award, except when the subcontract—

(1) Is for the acquisition of a commercial item; or

(2) Is performed entirely outside the United States.

27. 552.270-30 PRICE ADJUSTMENT FOR ILLEGAL OR IMPROPER ACTIVITY (JUN 2011)

(Applicable to leases over the Simplified Lease Acquisition Threshold.)

(a) If the head of the contracting activity (HCA) or his or her designee determines that there was a violation of subsection 27(a) of the Office of Federal Procurement Policy Act, as amended (41 U.S.C. 423), as implemented in the Federal Acquisition Regulation, the Government, at its election, may—

LESSOR: _____ GOVERNMENT: _____

(1) Reduce the monthly rental under this lease by five percent of the amount of the rental for each month of the remaining term of the lease, including any option periods, and recover five percent of the rental already paid;

(2) Reduce payments for alterations not included in monthly rental payments by five percent of the amount of the alterations agreement; or

(3) Reduce the payments for violations by a Lessor's subcontractor by an amount not to exceed the amount of profit or fee reflected in the subcontract at the time the subcontract was placed.

(b) Prior to making a determination as set forth above, the HCA or designee shall provide to the Lessor a written notice of the action being considered and the basis thereof. The Lessor shall have a period determined by the agency head or designee, but not less than 30 calendar days after receipt of such notice, to submit in person, in writing, or through a representative, information and argument in opposition to the proposed reduction. The agency head or designee may, upon good cause shown, determine to deduct less than the above amounts from payments.

(c) The rights and remedies of the Government specified herein are not exclusive, and are in addition to any other rights and remedies provided by law or under this lease.

28. 52.215-10 PRICE REDUCTION FOR DEFECTIVE COST OR PRICING DATA (AUG 2011)

(Applicable when cost or pricing data are required for work or services over \$750,000.)
This clause is incorporated by reference.

29. 552.270-13 PROPOSALS FOR ADJUSTMENT (OCT 2016)

This clause is incorporated by reference.

30. CHANGES (MAR 2013)

(a) The LCO may at any time, by written order, direct changes to the Tenant Improvements within the Space, Building Security Requirements, or the services required under the Lease.

(b) If any such change causes an increase or decrease in Lessor's costs or time required for performance of its obligations under this Lease, whether or not changed by the order, the Lessor shall be entitled to an amendment to the Lease providing for one or more of the following:

- (1) An adjustment of the delivery date;
- (2) An equitable adjustment in the rental rate;
- (3) A lump sum equitable adjustment; or
- (4) A change to the operating cost base, if applicable.

(c) The Lessor shall assert its right to an amendment under this clause within 30 days from the date of receipt of the change order and shall submit a proposal for adjustment. Failure to agree to any adjustment shall be a dispute under the Disputes clause. However, the pendency of an adjustment or existence of a dispute shall not excuse the Lessor from proceeding with the change as directed.

(d) Absent a written change order from the LCO, or from a Government official to whom the LCO has explicitly and in writing delegated the authority to direct changes, the Government shall not be liable to Lessor under this clause.

LESSOR: _____ GOVERNMENT: _____

31. 552.215-70 EXAMINATION OF RECORDS BY GSA (JUN 2016)
(Applicable to leases over the Simplified Lease Acquisition Threshold.)
This clause is incorporated by reference.

32. 52.215-2 AUDIT AND RECORDS—NEGOTIATION (JUN 2020)
(Applicable to leases over the Simplified Lease Acquisition Threshold.)
This clause is incorporated by reference.

33. 52.233-1 DISPUTES (MAY 2014)
This clause is incorporated by reference.

34. 52.222-26 EQUAL OPPORTUNITY (SEP 2016)
This clause is incorporated by reference.

35. 52.222-21 PROHIBITION OF SEGREGATED FACILITIES (APR 2015)
This clause is incorporated by reference.

36. 52.219-28 POST-AWARD SMALL BUSINESS PROGRAM REREPRESENTATION (SEP 2021)
(Applicable to leases exceeding the micro-purchase threshold.)
This clause is incorporated by reference.

37. 52.222-35 EQUAL OPPORTUNITY FOR VETERANS (JUN 2020)
(Applicable to leases \$150,000 or more, total contract value.)

(a) *Definitions.* As used in this clause-

“Active duty wartime or campaign badge veteran,” “Armed Forces service medal veteran,” “disabled veteran,” “protected veteran,” “qualified disabled veteran,” and “recently separated veteran” have the meanings given at Federal Acquisition Regulation (FAR) [22.1301](#).

(b) Equal opportunity clause. The Contractor shall abide by the requirements of the equal opportunity clause at 41 CFR 60-300.5(a), as of March 24, 2014. This clause prohibits discrimination against qualified protected veterans, and requires affirmative action by the Contractor to employ and advance in employment qualified protected veterans.

(c) Subcontracts. The Contractor shall insert the terms of this clause in subcontracts valued at or above the threshold specified in FAR [22.1303](#)(a) on the date of subcontract award, unless exempted by rules, regulations, or orders of the Secretary of Labor. The Contractor shall act as specified by the Director, Office of Federal Contract Compliance Programs, to enforce the terms, including action for noncompliance. Such necessary changes in language may be made as shall be appropriate to identify properly the parties and their undertakings.

LESSOR: _____ GOVERNMENT: _____

38. 52.222-36 EQUAL OPPORTUNITY FOR WORKERS WITH DISABILITIES (JUN 2020)

(Applicable to leases over \$15,000 total contract value.)

(a) Equal opportunity clause. The Contractor shall abide by the requirements of the equal opportunity clause at 41 CFR 60-741.5(a), as of March 24, 2014. This clause prohibits discrimination against qualified individuals on the basis of disability, and requires affirmative action by the Contractor to employ and advance in employment qualified individuals with disabilities.

(b) Subcontracts. The Contractor shall include the terms of this clause in every subcontract or purchase order in excess of the threshold specified in Federal Acquisition Regulation (FAR) [22.1408\(a\)](#) on the date of subcontract award, unless exempted by rules, regulations, or orders of the Secretary, so that such provisions will be binding upon each subcontractor or vendor. The Contractor shall act as specified by the Director, Office of Federal Contract Compliance Programs of the U.S. Department of Labor, to enforce the terms, including action for noncompliance. Such necessary changes in language may be made as shall be appropriate to identify properly the parties and their undertakings.

39. 52.222-37 EMPLOYMENT REPORTS ON VETERANS (JUN 2020)

(Applicable to leases \$150,000 or more, total contract value.)
This clause is incorporated by reference.

40. 52.209-6 PROTECTING THE GOVERNMENT'S INTEREST WHEN SUBCONTRACTING WITH CONTRACTORS DEBARRED, SUSPENDED, OR PROPOSED FOR DEBARMENT (JUN 2020)

(Applicable to leases over \$35,000 total contract value.)
This clause is incorporated by reference.

41. 52.215-12 SUBCONTRACTOR CERTIFIED COST OR PRICING DATA (JUN 2020)

(Applicable if over \$750,000 total contract value.)
This clause is incorporated by reference.

42. 52.219-8 UTILIZATION OF SMALL BUSINESS CONCERNS (OCT 2018)

(Applicable to leases over the Simplified Lease Acquisition Threshold.)
This clause is incorporated by reference.

43. 52.219-9 SMALL BUSINESS SUBCONTRACTING PLAN (SEP 2021) ALTERNATE III (JUN 2020)

(Applicable to leases over \$750,000 total contract value.)
This clause is incorporated by reference.

LESSOR: _____ GOVERNMENT: _____

44. 52.219-16 LIQUIDATED DAMAGES—SUBCONTRACTING PLAN (SEP 2021)

(Applicable to leases over \$750,000 total contract value.)
This clause is incorporated by reference.

45. 52.204-10 REPORTING EXECUTIVE COMPENSATION AND FIRST-TIER SUBCONTRACT AWARDS (JUN 2020)

(Applicable if over \$30,000 total contract value.)
This clause is incorporated by reference.

46. 52.204-25 PROHIBITION ON CONTRACTING FOR CERTAIN TELECOMMUNICATIONS AND VIDEO SURVEILLANCE SERVICES OR EQUIPMENT (DEVIATION 20-05) (DEC 2020) PLEASE SEE EXHIBIT I.

47. INTENTIONALLY DELETED

48. 52.204-19 INCORPORATION BY REFERENCE OF REPRESENTATIONS AND CERTIFICATIONS (DEC 2014)

This clause is incorporated by reference.

LESSOR: _____ GOVERNMENT: _____



ROMAN BUSTILLOS, P.E.
President
RANDY P. BROCK, P.E.
Executive Vice President
SERGIO J. ADAME, P.E.
Vice President - Engineering
AARON ALVARADO, R.P.L.S.
Vice President - Surveying

METES AND BOUNDS DESCRIPTION
(1820 AMERICAN DRIVE)

TBPE Reg. No. F-737
TBPLS Reg. No. 101314-00

A 1.7651 acres parcel situate within the corporate limits of the City of El Paso, El Paso County, Texas as a portion of Lot 2, Block 4, El Paso International Airport Tracts Unit Ten, as filed in Volume 53, Page 12, El Paso County Plat Records and being more particularly described by metes and bounds as follows:

COMMENCING for reference at a city monument found at the centerline right-of-way intersection of Piper Court (68 feet wide) and American Drive (68 feet wide); **WHENCE**, a city monument found at the centerline right-of-way intersection of Northrop Road (68 feet wide) and said American Drive, bears North 26°55'25" East (North 23°46'33" East-record), a distance of 758.41 feet (758.06 feet-record); **THENCE**, leaving the intersection of said Piper Court and American Drive and following the centerline of said American Drive, North 02°05'51" East (North 01°01'53" East-record), a distance of 54.00 feet to a concrete nail with shiner found for a point of curvature; **THENCE**, continuing along the centerline of said American Drive along the arc of a curve to the right having a radius of 763.01 feet, a central angle of 15°25'08", an arc length of 205.33 feet and whose long chord bears North 09°48'25" East, a distance of 204.72 feet; **THENCE**, leaving the centerline of said American Drive, South 72°29'01" East, a distance of 34.00 feet to a 1/2-inch rebar with survey cap No. "TX 6223" set for the beginning of a non-tangent curve to the right on the southeasterly right-of-way line of said American Drive for the southwesterly corner and the **POINT OF BEGINNING** of the parcel herein described;

THENCE, following the southeasterly right-of-way line of said American Drive along the arc of said non-tangent curve to the right having a radius of 729.01 feet, a central angle of 14°52'50", an arc length of 189.33 feet and whose long chord bears North 24°57'24" East, a distance of 188.80 feet to a 1/2 inch rebar with survey cap No. "TX 6223" set for the northwesterly corner of the parcel herein described;

THENCE, leaving the southeasterly right-of-way line of said American Drive, South 42°54'09" East, a distance of 522.14 feet to a mag nail set on the southeasterly boundary line of said Lot 2 for the northeasterly corner of the parcel herein described;

THENCE, following the southeasterly boundary line of said Lot 2, South 47°05'51" West (South 45°58'07" West-record), a distance of 135.08 feet to a bridge nail found for the southeasterly corner of the parcel herein described;

THENCE, leaving the southeasterly boundary line of said Lot 2, North 47°56'45" West, a distance of 452.73 feet to the **POINT OF BEGINNING**.

Said parcel containing 1.7651 acres (76,887.7 square feet), more or less and being subject to all easements, restrictions and covenants of record.

Basis of Bearing is the Texas State Plane Coordinate System, Central Zone 4203, North American Datum of 1983 (NAD 83) (2011), determined via the El Paso County Virtual Reference Station (VRS) Network.

Aaron Alvarado, TX R. P. L. S. No. 6223
Date: September 13, 2021
05100-115D-1820 AMERICAN LEASE DESC

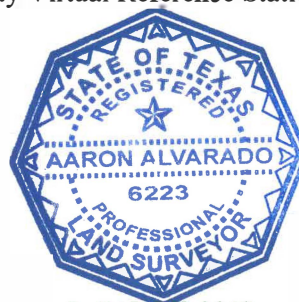

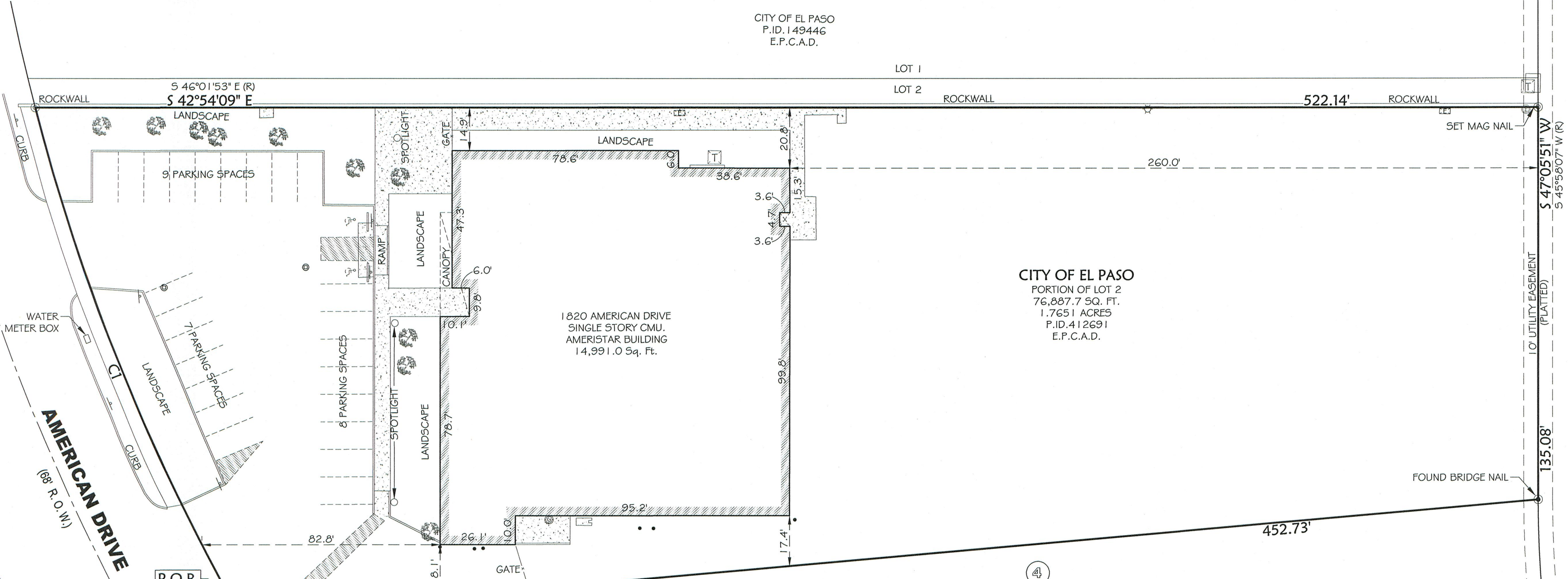
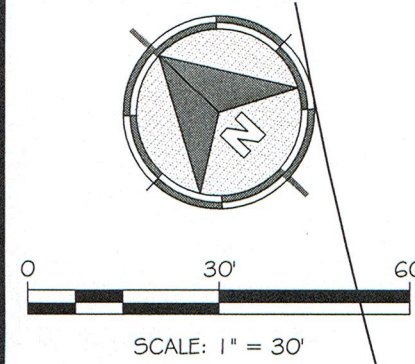

EL PASO INTERNATIONAL AIRPORT TRACTS UNIT TEN

VOLUME 53, PAGE 12, E.P.C.P.R.

LINE TABLE		
LINE #	BEARING	DISTANCE
L1	S72°29'01"E	34.00

CURVE TABLE					
CURVE	RADIUS	DELTA ANGLE	ARC LENGTH	CHORD BEARING	CHORD LENGTH
C1	729.01	14°52'50"	189.33	N24°57'24"E	188.80
C2	763.01	15°25'08"	205.33	N09°48'25"E	204.72

SUPPLEMENTAL NOTES

1. BASIS OF BEARING IS THE TEXAS STATE PLANE COORDINATE SYSTEM, CENTRAL ZONE, NO. 4203, NORTH AMERICAN DATUM OF 1983 (N.A.D. 83), DETERMINED VIA THE EL PASO COUNTY VIRTUAL REFERENCE STATION (V.R.S.) NETWORK.
2. SUBJECT PROPERTY IS LOCATED IN ZONE "C" (DESIGNATES AREAS OF MINIMAL FLOODING) AS DETAILED ON CITY OF EL PASO FLOOD INSURANCE RATE MAP COMMUNITY PANEL NO. 480214 0035B, DATED OCTOBER 15, 1982.
3. SUBJECT PROPERTY IS ZONED "C-4" (COMMERCIAL DISTRICT) AS DESIGNATED AT THE CITY OF EL PASO G.I.S. WEBSITE WWW.PDNMAPA.COM. SETBACKS FOR ZONE "C-4": (OTHER PERMITTED USES)
 FRONT: 0'
 REAR: 10'
 SIDE: 10' WHEN ABUTTING A RESIDENTIAL OR APARTMENT DISTRICT
 SIDE STREET: 10'
4. SURVEY WAS PERFORMED WITHOUT THE BENEFIT OF A TITLE COMMITMENT, EASEMENTS AND OTHER ENCUMBRANCES MAY EXIST WHERE NONE ARE SHOWN.

CERTIFICATION:

I HEREBY CERTIFY THAT THIS SURVEY PLAT AND THE ACTUAL SURVEY ON THE GROUND UPON WHICH IT IS BASED WERE PERFORMED BY ME OR UNDER MY DIRECT SUPERVISION; THAT I AM RESPONSIBLE FOR THIS SURVEY; THAT THIS SURVEY MEETS THE MINIMUM STANDARDS FOR SURVEYING IN TEXAS AND THAT IT IS TRUE AND CORRECT TO THE BEST OF MY KNOWLEDGE AND BELIEF.

Aaron Alvarado 09/13/21
 AARON ALVARADO, TX. RPLS NO. 6223



DRAWN BY: A.G.	LEASE BOUNDARY & IMPROVEMENT SURVEY	
APPROVED BY: A.A.	(1820 AMERICAN DRIVE)	
SCALE: 1"=30'	PORTION OF LOT 2, BLOCK 4, EL PASO INTERNATIONAL AIRPORT TRACTS, UNIT TEN,	
DATE: 09/02/2021	CITY OF EL PASO, EL PASO COUNTY, TEXAS.	
JOB NO. 05100-115D	REVISION:	SHEET 1 OF 1
	DATE:	

LEGEND

PROJECT BOUNDARY	—————
TRACT/LOT/RIGHT-OF-WAY LINE	=====
CENTERLINE OF RIGHT-OF-WAY	- - - - -
EASEMENT LINE	- · - · -
CLEANOUT	⊙
GAS METER	⊙
ELECTRIC METER	⊙
ELECTRIC/ TRAFFIC SIGNAL BOX	⊞
ELECTRIC TRANSFORMER	⊞
LIGHT POLE/STANDARD	⊙
PARKING/ROAD SIGN	⊙
BOLLARD	•
HANDICAP PARKING SPACE	⊙
CONCRETE AREA	▨
EXISTING BUILDING	▨
PAINTED NO PARKING ZONE	▨
SET 1/2" REBAR WITH SURVEY CAP NO. "TX 6223" UNLESS OTHERWISE NOTED	⊙
LOT NUMBER	2
BLOCK NUMBER	④

LESSOR: _____ GOVERNMENT:
 LEASE NO. HSBP-7421-L-DA1203

B BROCK & BUSTILLOS INC.
 CONSULTING CIVIL ENGINEERS
 LAND SURVEYORS
 TBPE REG. NO. F-737
 TBPLS REG. NO. 101314-00

417 EXECUTIVE CENTER
 EL PASO, TEXAS 79902
 www.brockbustillos.com
 PH (915) 542-4900
 FAX (915) 542-2867

Sep 13, 2021 5:10pm
 S:\Projects\05100-115D-City of El Paso\115D-1820 AMERICAN DRIVE.dwg

AMERISTAR FLOOR PLAN ²



PRINTED: 8/18/2021 09:22:00 AM

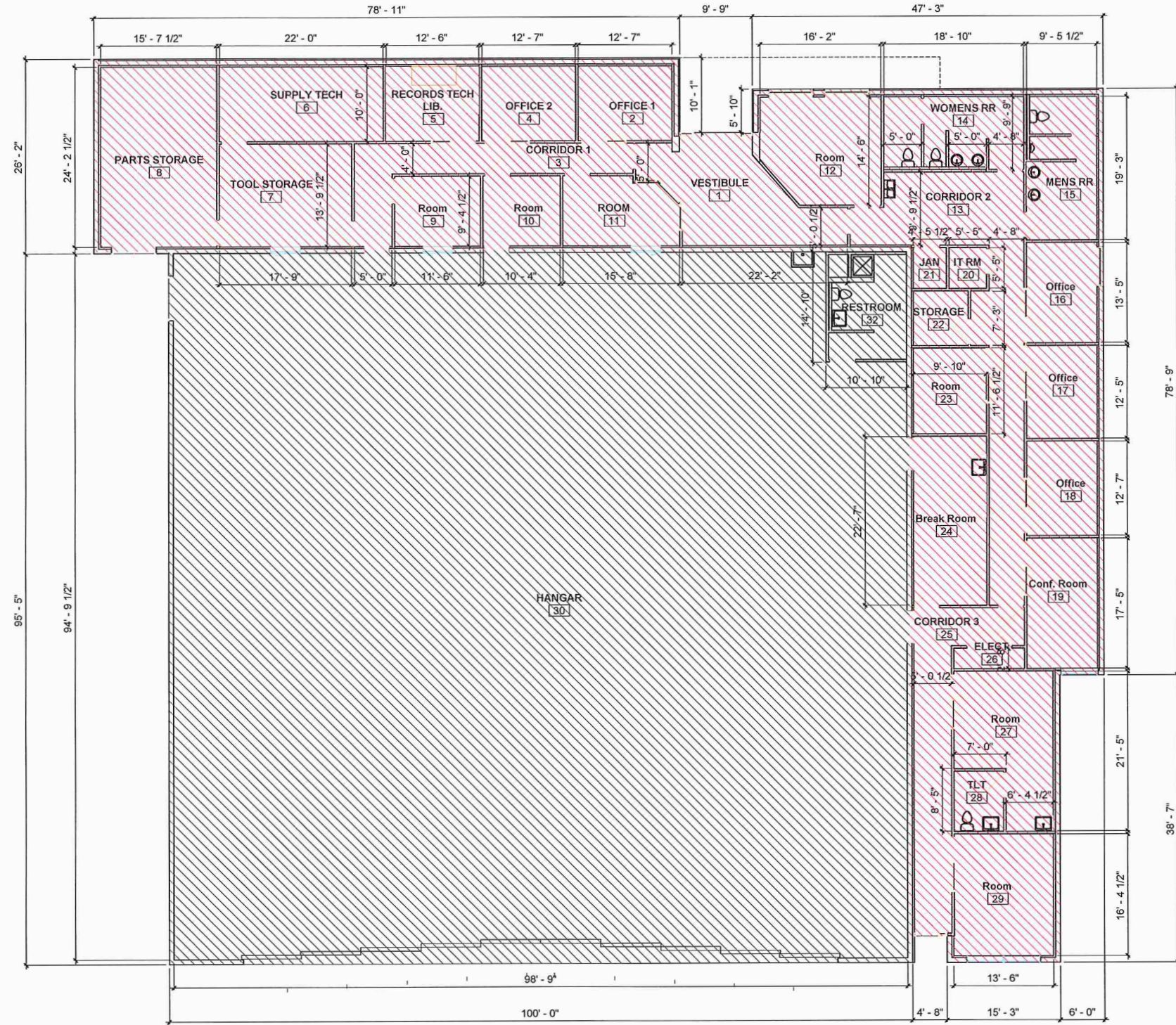

OFFICE AREA-	5,476 GROSS SQ. FT.
HANGAR AREA-	9,543 GROSS SQ. FT.
TOTAL	15,019 GROSS SQ. FT.

EXISTING FLOOR PLAN **1**
SCALE 1/8" = 1'-0"

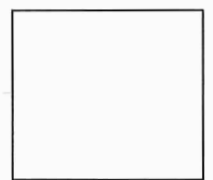
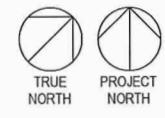

AMERISTAR HANGAR RENOVATION
1820 AMERICAN DRIVE EL PASO TEXAS 799

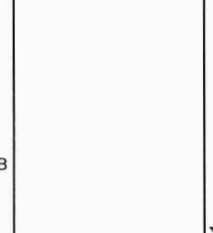

NOT FOR CONSTRUCTION

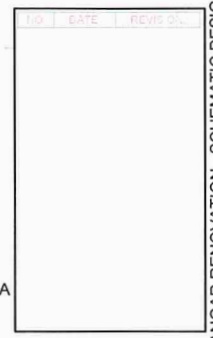

SHEET:
A-101
GROSS AREA FLOOR PLAN

2021-01_AMERISTAR HANGAR RENOVATION_SCHEMATIC DESIGN, JUNE 14, 2021

Y:\2021\2021-01 EPIA Hanger Remodel (Ameristar Hangar) El Paso Airport\2 CADD FILES\0 Revit\2021-01 AMERISTAR HANGAR RENOVATION.rvt



U.S. Customs and
Border Protection



Statement of Work (SOW)
Ameristar Hangar Lease, El Paso International Airport

1. BACKGROUND:

The Customs and Border Protection (CBP), Office of Facilities Management and Engineering Directorate (FM&E) is responsible for the coordination of all real property management functions within CBP, in addition to all aspects of financial management and budgeting, logistical support, building management services, investment planning, and life cycle management of real property.

This project is to meet the mission needs of the El Paso Air Branch, El Paso Flight Operations, to improve and expand the Air Branch's hangar and office space facilities. The approximately 15,019 square foot Ameristar facility represents a unique opportunity to provide the needed additional space for personnel and equipment, and to have secure parking for its current and future personnel.

The Ameristar Hangar has been vacant for some time and is not currently in an acceptable condition. CBP surveyed the building and found the structure sound, but with minor leaks, and a significant amount of exterior paving to be repaired. The Contractor is expected to provide the design drawings, engineering and construction for the repairs to the building and grounds and provide the tenant improvements as described herein.

The ultimate purpose of this project is to confirm to existing Air and Marine design requirements and in accordance with Air Branch's Table of Organization and Equipment (TO&E) dated April 22, 2020. A basis of design has been developed between BPAM and the AMO detailing operation provisions for administrative and staff support size.

The project location is:

1820 American Drive
El Paso, TX 79925-1129

EXHIBIT D

2. SCOPE:

This is a design and build project. CBP has provided the basis of design and a layout of the desired layout of the office space for the purpose of tenant improvement design drawings. A schematic design and a space requirement is included below as Attachment A. As it is expected that the Contractor will include all reasonable repairs, the tenant improvements in this project shall include demolition and reconstruction of existing office space, and certain specified work on the apron, including removal of a stone wall and the repairing of the entire apron and parking lot. "Repairing of the entire apron" is defined as making it safe for aircraft with the expectation of FOD elimination.

Air Branch standard security, communications and fire-life safety additions, including power, compressed air and other facilities required for aircraft maintenance is included in this project's scope. Interior walls, doors, ceilings, flooring and other finishes, light fixtures, circuits and electrical distribution, fire alarms, fire suppression systems, plumbing, heating and air conditioning distribution shall be included in this project. Layouts and details shall be determined by the completed and approved drawings. All work shall be inspected by a civil authority and declared fit for occupancy at the conclusion of the Work described.

Because this is in a non-governmental owned building, a building permit and specialty permits with inspections by municipal and airport authorities are required.

3. APPLICABLE DOCUMENTS:

Appendix A, Ameristar Hangar Diagramatic Space Massing
Appendix B, Aerial View of Hangar Property
Appendix C, Scope of Work
This SOW.

4. SPECIFIC TASKS:

Upon the signing of the Lease, the Contractor shall provide Design Intent Drawings ("DIDs") based on the information provided by the Government. The DIDs shall be of a quality which could easily be understood by general and specialty contractors and shall be inspected and approved by local municipal governmental agencies whose job it is to enforce all applicable building codes. Once the construction drawings have been approved by the local authorities, they shall be submitted to CBP as "Approved For Construction Drawings" and CBP shall review and comment. If they are acceptable as described in Paragraph 5.5 of this SOW, the Government shall notify the Lessor that they are acceptable and issue the Notice to Proceed for the construction.

5. DELIVERABLES AND DELIVERY SCHEDULE:

EXHIBIT D

General – All submittals shall be provided through a Material Approval Submittal (MAS) process and submitted to the Contract Specialist (CS)/Contracting Officer (CO) and COR concurrently in a PDF file format. Unless noted otherwise, all deliverables shall be in electronic format and submitted via email. All durations in this SOW are in working days, defined as weekdays, excluding Saturdays, Sundays and federal holidays.

- 5.1. Accuracy – All deliverables shall be accurate in presentation, content, and shall adhere to the guidelines set forth in this document. All documentation presented to CBP shall be complete, correct, clear and consistent.
- 5.2. Clarity – Deliverables shall be clear and concise.
- 5.3. Timeliness – Deliverables shall be submitted on or before the due date specified in SOW. A deliverable is considered timely if submitted on or before the date specified in this SOW and if the Government provides any written notifications of deficiencies, the Contractor corrects the deficiencies within five (5) working days.

5.4. Submittals

5.5. Pre-Construction Submittals

5.5.1. Construction Schedule and Initial Construction Meeting. The Contractor shall furnish a detailed construction schedule to the Government within seven (7) working days of issuance of the NTP. The schedule shall provide sufficient detail to include design time, method of approach and milestone and completion dates relating to the various phases or sequences of the project. The Project Schedule shall be in electronic format, using established software such as Microsoft Project or other recognized industry standard software. The schedule shall also indicate the dates available for Government contractors to install telephone/data lines of equipment, if needed. Within seven (7) working days of NTP, Contractor shall initiate a construction meeting. This meeting may be held in person or virtually at the discretion of the Government. The Contractor will have contractor representatives including its architect, engineers, general contractor and subcontractor representatives in attendance. The Contractor shall keep meeting minutes of the discussion topics and attendance.

5.5.2. Design Intent Drawings – Upon final execution of the Lease, the Contractor shall prepare and submit 65% Design Intent Drawings (DIDs) of the proposed construction, including the apron and front parking lot and based upon the “Ameristar Hangar Diagrammatic Massing”, Appendix A to this SOW, within forty-five (45) working days of the final execution of the Lease.

5.5.2.1. The DIDs are defined as layout line drawings of the leased space reflecting all lease requirements, showing partitions and doors, schematic demolition, voice, data and electrical outlet locations, finishes, generic furniture layout, and any additional details necessary to communicate the design intent

EXHIBIT D

to the Contractor's architect for the purpose of preparing the construction documents (CDs). A full DID set must include the following elements:

- 5.5.2.1.1.** Cover Sheet
- 5.5.2.1.2.** Demolition Plan, if applicable
- 5.5.2.1.3.** Construction (Partition) Plan
- 5.5.2.1.4.** Power/Communication (Electrical) Plan
- 5.5.2.1.5.** Furniture Plan
- 5.5.2.1.6.** Finish Plan

5.5.3. The Government shall have ten (10) working days to review and comment on the DIDs.

5.5.4. 95% DIDs – The Contractor shall prepare and submit 95% drawings of the proposed construction within ten (10) working days of the Government's approval of the 65% DIDs.

5.5.5. 100% DIDs - The Contractor shall submit the complete 100% drawings within five (5) working days of the Government's approval of the 95% drawings.

5.5.6. Constuction Drawings – The Lessor must complete CDs not later than fifteen (15) working Days following the approval of the 100% DIDs. The Government shall have ten (10) working days to review the CDs.

5.6. In Progress Report Requirements

5.6.1. Daily Reports - The Contractor shall provide daily status reports to the COR and/or the Technical Point of Contract/Project Manager throughout the duration of the project until all work is completed. These updates shall be transmitted via email by 4:00 PM (Local Time) each Friday.

5.6.2. Weekly Progress Color Photos – The Contractor shall provide weekly progress color photos. Photos shall be in digital format and be of size and quality that when printed on 8 ½" x 11" stock can show the detail of the work. Photos shall be of a quantity and quality to adequately show progress of the work being executed and related activities. Provide a minimum of six (6) progress photos per week. Photos shall be transmitted via email along with weekly reports by 4:00 PM (Local Time) each Friday.

5.7. Post-Construction Submittals

5.7.1.1. The Contractor shall furnish the following Post-Construction Submittals.

5.7.1.2. Ten (10) working days prior to the completion of the Space, the Contractor shall issue written notice to the Government to schedule the inspection of the Space for acceptance. The Government shall accept the Space only if the construction of the building shell and tenant improvements and the approved

EXHIBIT D

DIDs, if applicable, is substantially complete, a Certificate of Occupancy (C of O) has been issued, and the Building improvements necessary for acceptance as described in the 100% CDs are completed.

- 5.7.1.3. The Space shall be considered substantially completed only if the Space may be used for its intended purpose and completion of remaining work will not interfere unreasonably with the Government's enjoyment of the Space. Acceptance shall be final and binding upon the Government with respect to conformance of the completed TI's to the approved DIDs, with the exception of items identified on a punch list generated as a result of the inspection.
- 5.7.1.4. The Contractor shall provide a valid Certificate of Occupancy issued by the local jurisdiction for the intended use of the Government. If the local jurisdiction does not issue a C of O or if the C of O is not available, the Contractor may satisfy this condition by providing a report prepared by a licensed fire protection engineer that indicates the Space and Building and Grounds are compliant with all applicable local codes and ordinances and all fire protection and life safety-related requirements.
- 5.7.1.5. The Contractor shall provide compaction reports of the native and sub-base prior to placement of the road base. Acceptance by a licensed soils engineer after testing shall be proof enough that the 90% compaction has been achieved, and all testing and reports shall be submitted at the close of construction.
- 5.7.1.6. The Contractor shall provide 1-year warranties for labor and equipment work.
- 5.7.1.7. Not later than thirty (30) working days after the acceptance of the Space, the Contractor shall furnish to the Government a complete set of Computer Aided Design (CAD) files of as-built floor plans showing the Work reflected in the DIDs and CDs. As-built drawings shall include those for civil, architectural, mechanical, electrical and plumbing including, but not limited to, those for IT, communications, security and fire protection.
- 5.7.1.8. All post-construction submittals shall be reviewed and approved by the COR before final acceptance of project completion. Electronic copies must be delivered via Email, or on CD or DVD; USB Flash Drive (Thumb Drive) is not acceptable.

5.8. Submittals shall be provided for the following requirements:

- 5.8.1. The Contractor shall deliver a Two Week Look Ahead Schedule within seven (7) working days of issuance of the Notice To Proceed. This schedule shall clearly show the detail of task(s) time lines shown on the Project Schedule. This schedule shall be updated weekly and emailed to the COR by close of business each Friday during the entire performance period of this order.

EXHIBIT D

5.8.2. The Contractor shall prepare and submit a Task Specific Accident Prevention Plan (APP) and Task Specific Safety Plan within seven (7) working days of Notice to Proceed. This plan shall address the requirements of FAR 52.236-13, Accident Prevention (Nov 1991). This plan shall be submitted for informational purposes.

5.8.3. The Contractor shall prepare and submit a work task Quality Control Plan that outlines procedures and measures that the Contractor shall take to provide project oversight, quality standards and auditing, roles and responsibilities, and identifying lines of communication to Contractor management personnel available to the government.

5.8.4. The Contractor shall provide operations and maintenance (O&M) documentation to the COR within seven (7) working days of final acceptance of the project by the COR.

6. GOVERNMENT FURNISHED EQUIPMENT AND INFORMATION:

6.1. The Government will not provide any facilities, equipment, or materials unless specifically listed in this SOW. Portable toilets, handwashing, and break area accommodations are the Contractor's responsibility and to be located exterior near the entrance to the worksite.

6.2. The Contractor will be allowed to use electrical service on site (120 volt) unless such use becomes a nuisance to CBP operations.

7. PLACE OF PERFORMANCE:

The project location is:

1820 American Drive
El Paso, TX 79925-1129

8. PERIOD OF PERFORMANCE:

The Contractor shall complete the design and the construction within the time frame as specified in the Lease.

9. SECURITY:

9.1. The work conducted on this contract will be For Official Use Only (FOUO) with appropriate markings on all documents produced in support of this SOW. The

EXHIBIT D

Contractor shall comply with Customs and Border Protection (CBP) administrative, physical and technical security controls to ensure that the Government's security requirements are met.

9.2. PHYSICAL SECURITY: The Contractor shall be responsible for safeguarding all Government equipment, information and property provided for contractor use. At the close of each work period, Government facilities, equipment, and materials shall be secured.

9.3. CBP BACKGROUND INVESTIGATION (BI) CLEARANCE:

(a) The Contractor shall comply with the CBP administrative, physical, and technical security controls to ensure the federal government's security requirements are met.

(b) Contractors hired for work within the United States or its territories and possessions, and who require access to the Department of Homeland Security (DHS) owned or controlled facilities, information systems, security items, or products and/or sensitive but unclassified information shall be U.S. Citizens and shall live within the United States or its territories.

(c) The Contractor must run a preliminary criminal background check on candidates prior to being referred for interviewing. Only candidates who pass the preliminary criminal background check performed by the Contractor will perform work under this SOW.

(d) All contractors hired for work must pass a criminal background check, which will be performed by CBP, Security Programs Division prior to being allowed full access to government systems. Failure to pass a criminal background check or a thorough CBP background investigation completed by the CBP, Security Programs Division is grounds for removal from working under this SOW.

(d) The Contractor shall submit within ten (10) working days after contract award, a list containing the full name, and date of birth and other information as required by CBP of these candidates who have successfully passed the preliminary background investigation. This shall be coordinated with the COR.

(e) The continuous failure to meet the requirement to provide cleared personnel is grounds for termination of the task order, unless cleared personnel are timely provided as replacements. The Contractor must provide a qualified replacement capable of passing a BI for any person who fails to successfully pass a BI. This policy applies to any personnel hired as replacements.

(f) Only persons that have been cleared by the CBP background check will be allowed access to the site for work being performed.

(g) All Contractor/construction personnel will be escorted by a Government appointed person while inside the Border Patrol Station.

10. SPECIAL CONSIDERATIONS:

10.1. **POINTS OF CONTACT:**

Lease Contracting Officer:

Chatigny Davis

214-334-1594

817-868-8661

chatigny.l.davis@cbp.dhs.gov

Contracting Officer's Representative:

Wayne Hughes

915-834-8512 – Work

915-526-0810

wayne.j.hughes@cbp.dhs.gov

Technical Point of Contact:

Charles Knief

949-877-9135

charles.l.knief@cbp.dhs.gov

END OF STATEMENT OF WORK

Appendix A

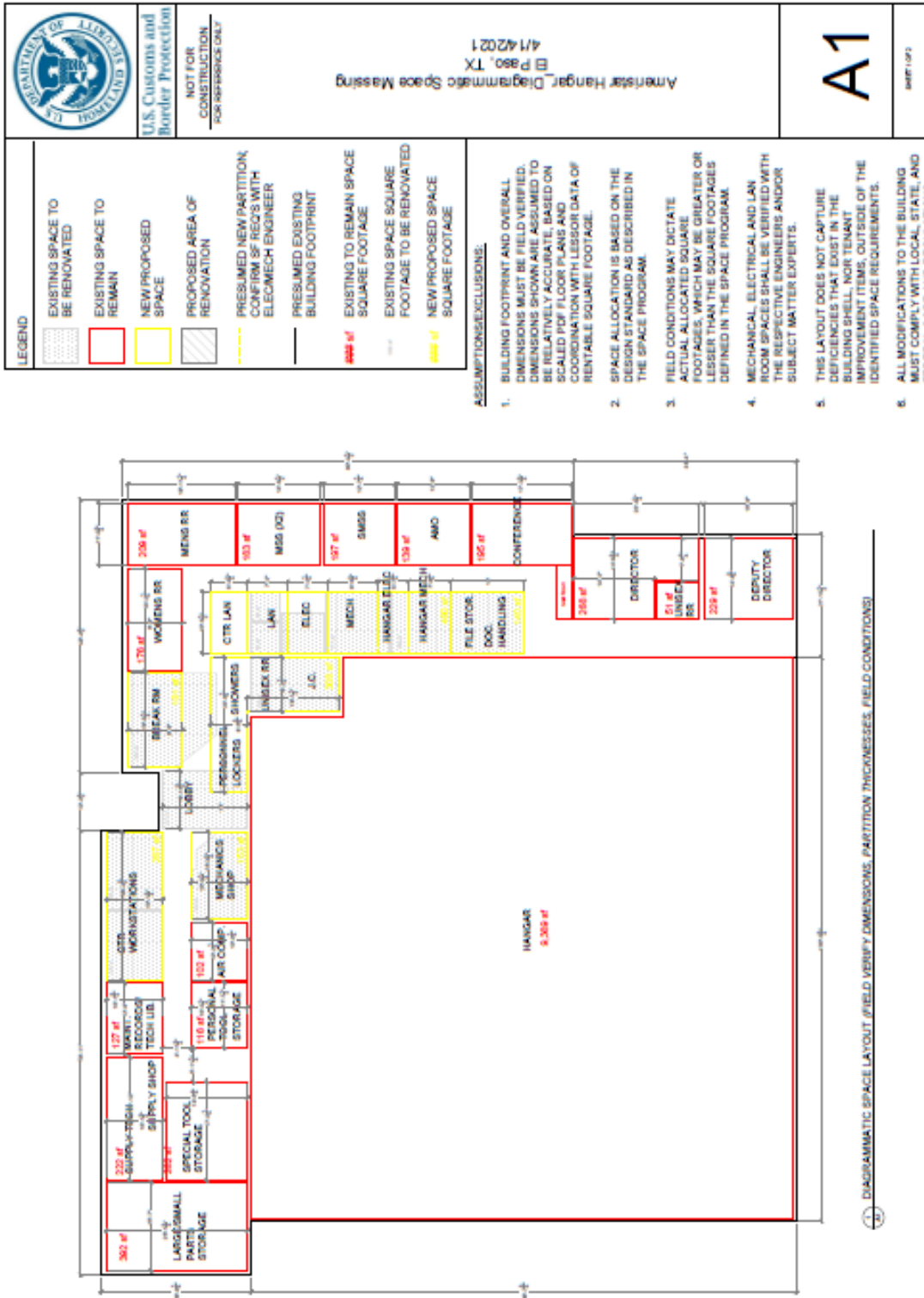

Appendix B

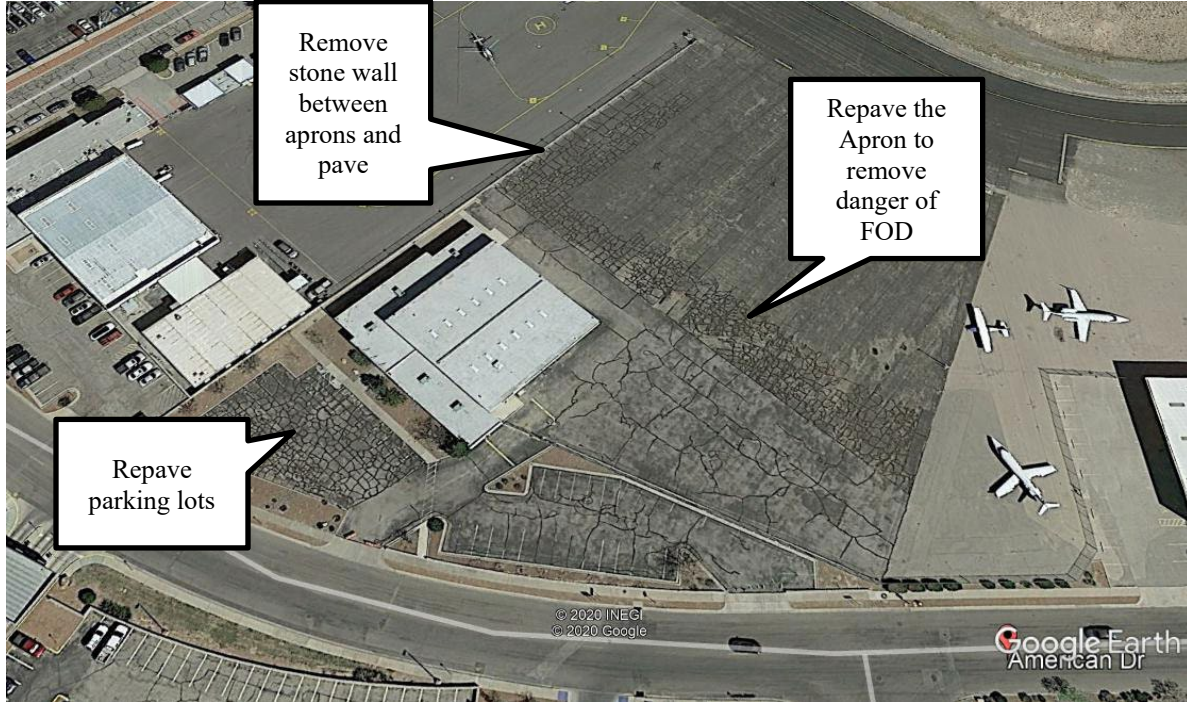

Appendix C

Agency Requirements

1. Repair or replace roof to make the structure weather and watertight.
2. Inspect and repair as necessary exterior walls to prevent further water incursion.
3. Remediate mold growth as noted in Mr. Van Winkle's November 6, 2020 report.
4. Repair and replace as necessary all sheet metal at roof edge, including gutters, downspouts, diverters, flashing and counter flashing, all elevations.
5. Hangar doors – replace seals, check and repair, if necessary, door motors and system controls. Check and repair or replace, if necessary, hangar door tracks.
6. Vehicle parking lot on American Drive seal coating and restriping.
7. Heating, Ventilation and Air Conditioning systems and distribution to areas that will not be altered that will not be altered.
8. Plumbing – all water and sewer service and distribution to/from areas that will not be altered by the Tenant Improvements.
9. Provide Electrical As-Constructed single line drawing for transformer(s), main panel and all subpanels, circuits and distribution.
10. Remove sign, repair face of building and repaint exterior, including all trim and doors.
11. Update and restore landscaping and irrigation system, including automatic timers.
12. Tenant Improvements – to be constructed and managed by the Contractor.
 - a. TI to meet the base requirements
 - b. TI to meet CBP Design Standards for AMO office space and AMO-specific requirements¹
 - c. Cost of TI Design
13. Apron Paving Renewal and striping
14. Removal of stone wall between 1820 American Drive and 6812 Northrop Drive and consequential grading and paving between the two properties. This should include topographical survey and civil engineering to ensure proper sheet flow away from hangars and other structures.
15. Card Readers at entry and at Vehicle Gate
16. Fire Alarm updating of base and interfacing with communications, and distribution
17. Camera systems – by CBP, but power and conduit run support in TI
18. Communications systems
 - d. Radio (by CBP) – power and conduit run support in TI
 - e. Telephone (by CBP) – power and conduit run support in TI
19. Provide and install, including piping, compressor on south elevation (or a better location TBD)
20. Resurface hangar floor.
21. Replace high bay lighting with LED fixtures².
22. Furnish and install roof access.

¹ See layout produced by CBP showing areas where existing walls are to be removed and reconstructed, and the addition of showers and other plumbing and electrical.

² All new light fixtures are to be LED. Existing fluorescent office fixtures are to be replaced with new LED.

AMERISTAR PARKING PLAN



American Dr

American Dr

Goo

LESSOR: _____ **GOVERNMENT:** _____

LEASE NO. HSBP-7421-L-DA1203

28
29

U.S. Department of Homeland Security
Facilities Management and Engineering
Border Patrol & Air and Marine (BPAM)
Program Management Office, Leasing Branch
150 Westpark Way, Suite 200
Euless, Texas 76040



U.S. Customs and
Border Protection

Notification to Offeror

Subject: Small Business Subcontracting Program

Dear Offeror,

This notification is being issued to inform you of the Small Business Subcontracting Program. In accordance with FAR Subpart 19.7, the Subcontracting Program is comprised of activities to ensure small businesses¹ receive a “maximum practicable opportunity” to participate in requirements awarded by Federal agencies, including subcontracts resulting from award of prime contracts which the Lessor agrees to implement to the “fullest extent”². When total contract value, including options, exceeds certain size thresholds, and the apparently successful offeror (prime contractor) is other than a small business, that offeror must submit an acceptable Small Business Subcontracting Plan in accordance with FAR 19.702. Attachment 1 is a leasing specific Small Business Subcontracting Plan template, subject to revision, intended to be used as a guideline (For information purposes only).

Small business size standards are government-wide and are determined based upon the North American Industry Classification System Codes (NAICS) with thresholds for the number of employees or annual revenue sales. **For lease acquisitions, the NAICS code is 531120, unless the real property is self-storage (531130), land (531130), or residential (531110). The current size standard for a small business under NAICS code 531120 is \$30.0M in annual average gross revenue of the concern for the last 3 fiscal years³. Note that this size standard is subject to revision.** Offerors will certify this information as part of the online Representations and Certifications to be completed during the System for Award Management (SAM) registration process.

a. Small Business Subcontracting Plan.

When is a Small Business Subcontracting Plan Required?

A Small Business Subcontracting Plan is required when:

- 1) the offeror is other than a small business (as defined by the NAICS code size standard), and
- 2) total contract value, including options, will exceed \$700,000⁴ or when a lease modification⁵ will change the value of the lease to exceed the \$700,000 threshold.

¹ This includes the small business socio-economic categories: small disadvantaged businesses, women- owned small businesses, veteran-owned small businesses, service-disabled veteran owned small businesses and HUBZone small businesses.

² FAR 52. 219-8, *Utilization of small business concerns*, incorporated in each lease terms and conditions.

³ Current size standard effective August 19, 2019, subject to change

⁴ Current threshold under FAR 19.702; subject to change

⁵ Per FAR 19.702(b)(4), subcontracting plans are not required for modifications that are within the scope of the contract and the contract does not contain the clause at 52.219-8, *Utilization of Small Business Concerns*.

The submitted plan must be reviewed and go through the current Small Business Subcontracting Plan approval process prior to lease award. Failure to submit an acceptable plan will make the Lessor ineligible for award as outlined in the General Clause “FAR 52.219-9, Small Business Subcontracting Plan.” At award, the subcontracting plan is incorporated into, and becomes a material part of, the lease. Note that the subcontracting plan remains in effect should the building ownership change, even when the new ownership is a small business. In instances where the Lessor’s size status changes from small to other than small as a result of a size re-representation as required by FAR 52.219-28, Post Award Small Business Program Rerepresentation, the Lease Contracting Officer (LCO) may require a small business subcontracting plan, as outlined under FAR 19.301-2(e).

b. Required Reports

After award, when a Small Business Subcontracting Plan is incorporated into the lease, Lessors are required by the terms of the lease to submit periodic reports each year so that the Government can determine the extent of compliance by the offeror with the subcontracting plan as outlined in FAR 52.219-9. These reports are the Standard Form 294 Subcontracting Report for Individual Contracts (ISR) (see Attachment 2) and the Summary Subcontract Report (SSR). The ISR is a semi-annual report which collects subcontracting award data from the Lessor for an individual lease. It is due by April 30, encompassing the reporting period October 1 – March 31, and by October 30, for the reporting period April 1 – September 30, for each year the lease is active. The SSR collects subcontracting award data for all contracts that a Lessor has been awarded, and is due by October 30.

Reports are required when due, regardless of whether there has been any subcontracting activity.

c. Reporting Method

The Lessor must manually submit their ISR to the Lease Contracting Officer, or their designated representative, via Standard Form 294. The SSR is submitted electronically on an annual basis via eSRS (available at <http://www.esrs.gov>).

d. Special Guidance for On-Airport Leases

The leasing program acquires space for agencies, such as the Transportation Security Agency (TSA), whose mission requires that GSA obtain space at airports, which is available from a single source, the airport authority. Further, airport authorities are generally quasi-governmental entities which are subject to the sub-contracting laws enacted by local legislatures. Often these local legislatures prescribe utilization of small businesses and minority businesses located within the city limits, for example. Under the governing rules for airport authorities, it may not be possible to accept the federal standards without corresponding action by their governing legislature or board. The subcontracts are already in place by the local authorities, making it impossible to “maximize practicable opportunities” for small businesses to perform. This also restricts the ability of the local government to comply with all 15 requirements for a subcontracting plan as required by FAR 52.219-9.

Further complicating this issue is the fact that on-airport leases for agencies such as TSA represent a very small percentage of the overall space leased at airports, making it impractical for the Lessor to implement the governing local subcontracting rules for the majority of their space while complying with federal standards with respect to the sub-contracting opportunities available under the GSA lease.

As outlined above, small business sub-contracting is required under certain circumstances under FAR 52.219-9. When leasing space from airports who do not qualify as a small business under NAICS code 531120, and are unable to accept the federal sub-contracting guidelines due to a conflict with legislatively enacted local subcontracting regulations, LCOs should obtain a copy of the corresponding local regulations and prepare an individual deviation justification for approval.

Upon approval of the individual deviation, LCOs may omit the following General Clauses from the lease:

- 52.219-8 Utilization of Small Business Concerns
- 52.219-9 Small Business Subcontracting Plan
- 52.219-16 Liquidated Damages—Subcontracting Plan
- 52.219-73 Goals for Subcontracting Plan

Note that, in instances where the LCO determines that there are no subcontracting opportunities (for example, the airport only employs city employees provided by the local entity), the LCO should instead process a waiver.

Attachment 1 - Small Business Subcontracting Plan Template

Attachment 2 - Subcontracting Report for Individual Contracts - SF 294 (Rev. 11/2021)

Offerors' Initial Representation: Complete the representation below, sign and return to the LCO or his/her designee. NOTE: The "Offeror," as used on this form, is the owner of the property offered, not an individual or agent representing the owner.

Lessors' Representation: Complete the annual representation below, sign and return to the ALCO or his/her designee via GSA's Real Estate Tax portal at ret.gsa.gov, or subsequent portal.

Novation Transferees' Representation: Complete the representation below, sign and return to the ALCO or his/her designee along with other required novation documentation.

=====
552.270-33 Foreign Ownership and Financing Representation for High-Security Leased Space.

FOREIGN OWNERSHIP AND FINANCING REPRESENTATION FOR HIGH-SECURITY LEASED SPACE (JUN 2021)

(a) *Definitions.* As used in this clause—

Financing means the process of raising or providing funds through debt or equity for purposes of meeting the requirements of the Lease, including, but not limited to, acquisition, maintenance, and construction of, or improvements to, the Property.

Foreign entity means a:

- (i) Corporation, company, business association, partnership, society, trust, or any other nongovernmental entity, organization, or group that is headquartered or organized under the laws of a country that is not the United States or a state, local government, tribe, or territory within the United States; or
- (ii) Government or governmental instrumentality that is not the United States Government.

Foreign person means an individual who is not:

- (i) A United States citizen; or
- (ii) An alien lawfully admitted for permanent residence in the United States.

Highest-level owner means the entity that owns or controls an immediate owner of the offeror or Lessor, or that owns or controls one or more entities that control an immediate owner of the offeror or Lessor. No entity owns or exercises control of the highest-level owner.

Immediate owner means an entity, other than the offeror or Lessor, that has direct control of the offeror or Lessor. Indicators of control include, but are not limited to, one or more of the following: ownership or interlocking management, identity of interests

LESSOR: _____ GOVERNMENT: _____

among family members, shared facilities and equipment, and the common use of employees.

Unique entity identifier means a number or other identifier used to identify a specific commercial, nonprofit, or Government entity. See www.sam.gov for the designated entity for establishing unique entity identifiers.

(b) *Timing.* The Offeror or Lessor shall complete this representation when submitting a proposal. If the Offeror is the successful awardee, the Offeror (now Lessor) shall review, update, and provide this representation on an annual basis, reflecting all changes to immediate owner, highest-level owner and financing during the preceding 1-year period, starting one year from the Lease Term Effective Date through final payment of any contract. If the Lessor intends to transfer the lease to a successor in interest under the circumstances set forth in FAR 42.1204, the Lessor shall submit this representation to the Lease Contracting Officer with any request to novate the lease. The Offeror or Lessor is responsible for the currency, accuracy and completeness of the data disclosed, and for any liability resulting from the Government's reliance on inaccurate or incomplete data.

(c) *Immediate owner.*

(1) The Offeror or Lessor represents that it does or does not have an immediate owner.

(2) If the Offeror or Lessor indicates "does" in paragraph (c)(1) of this clause, then enter the following information for the immediate owner. If the offeror or Lessor has more than one immediate owner (e.g., joint venture), then the offeror or Lessor shall provide the information for each entity.

Legal name (do not use a "doing business as" name)	
Unique entity identifier (if available)	

(3) If the Offeror or Lessor indicates "does" in paragraph (c)(1) of this clause, then complete this additional representation: Is the immediate owner a foreign entity?:

Yes or No.

(4) If the Offeror or Lessor indicates "does" in paragraph (c)(1) of this clause, then complete this additional representation: Is the immediate owner a foreign person?:

Yes or No.

(5) If the Offeror or Lessor indicates "Yes" in either paragraph (c)(3) or (4) of this clause, indicating that there is foreign ownership (as a foreign entity or foreign person), then enter the following information for the foreign owner (respond for each as applicable).

Physical address	
Country	

(d) Highest-level owner.

(1) The Offeror or Lessor represents that the immediate owner, if any, is or is not owned or controlled by another entity?

(2) If the Offeror or Lessor indicates "is" in paragraph (d)(1) of this clause, indicating that the immediate owner is owned or controlled by another entity, then enter the following information for the highest-level owner.

Legal name (do not use a "doing business as" name)	
Unique entity identifier (if available)	

(3) If the Offeror or Lessor indicates "is" in paragraph (d)(1) of this clause, then complete this additional representation: Is the highest-level owner a foreign entity?:

Yes or No.

(4) If the Offeror or Lessor indicates "is" in paragraph (d)(1) of this clause, then complete this additional representation: Is the highest-level owner a foreign person?:

Yes or No.

(5) If the Offeror or Lessor indicates "Yes" in either paragraph (d)(3) or (4) of this clause, indicating that there is foreign ownership (as a foreign entity or foreign person), then enter the following information for the foreign owner (respond for each as applicable).

Physical address	
Country	

(e) Financing entity.

(1) The Offeror or Lessor represents that the financing does or does not involve a foreign entity?

(2) The Offeror or Lessor represents that the financing does or does not involve a foreign person?

(3) If the Offeror or Lessor indicates "does" in either paragraph (e)(1) or (2) of this clause, indicating foreign financing (as a foreign entity or foreign person), then enter the following information for the foreign financing (respond for each as applicable).

Legal name (do not use a "doing business as" name)	
---	--

EXHIBIT G

Unique entity identifier (if available)	
--	--

Physical address	
Country	

(End of clause)

OFFEROR OR LESSOR NAME AND SIGNATURE	_____ Name	
	_____ Signature	_____ Date

LESSOR: _____ GOVERNMENT: _____

552.270-34 Access Limitations for High-Security Leased Space.

ACCESS LIMITATIONS FOR HIGH-SECURITY LEASED SPACE (JUN 2021)

(a) The Lessor, including representatives of the Lessor's property management company responsible for operation and maintenance of the leased space, shall not—

(1) Maintain access to the leased space; or

(2) Have access to the leased space without prior approval of the authorized Government representative.

(b) Access to the leased space or any property or information located within that Space will only be granted by the Government upon determining that such access is consistent with the Government's mission and responsibilities.

(c) Written procedures governing access to the leased space in the event of emergencies shall be documented as part of the Government's Occupant Emergency Plan, to be signed by both the Government and the Lessor.

(End of clause)

LESSOR: _____ GOVERNMENT: _____

GSAR 552.270-34 Access Limitations for
High-Security Leased Space JUN 2021
Page 1

52.204-25 PROHIBITION ON CONTRACTING FOR CERTAIN TELECOMMUNICATIONS AND VIDEO SURVEILLANCE SERVICES OR EQUIPMENT (DEVIATION 20-05) (DEC 2020)

(a) *Definitions.* As used in this clause—

“Backhaul” means intermediate links between the core network, or backbone network, and the small subnetworks at the edge of the network (e.g., connecting cell phones/towers to the core telephone network). Backhaul can be wireless (e.g., microwave) or wired (e.g., fiber optic, coaxial cable, Ethernet).

“Covered foreign country” means The People’s Republic of China.

“Covered telecommunications equipment or services” means—

(1) Telecommunications equipment produced by Huawei Technologies Company or ZTE Corporation (or any subsidiary or affiliate of such entities);

(2) For the purpose of public safety, security of Government facilities, physical security surveillance of critical infrastructure, and other national security purposes, video surveillance and telecommunications equipment produced by Hytera Communications Corporation, Hangzhou Hikvision Digital Technology Company, or Dahua Technology Company (or any subsidiary or affiliate of such entities);

(3) Telecommunications or video surveillance services provided by such entities or using such equipment; or

(4) Telecommunications or video surveillance equipment or services produced or provided by an entity that the Secretary of Defense, in consultation with the Director of National Intelligence or the Director of the Federal Bureau of Investigation, reasonably believes to be an entity owned or controlled by, or otherwise connected to, the government of a covered foreign country.

“Critical technology” means—

(1) Defense articles or defense services included on the United States Munitions List set forth in the International Traffic in Arms Regulations under subchapter M of chapter I of title 22, Code of Federal Regulations;

(2) Items included on the Commerce Control List set forth in Supplement No. 1 to part 774 of the Export Administration Regulations under subchapter C of chapter VII of title 15, Code of Federal Regulations, and controlled-

(i) Pursuant to multilateral regimes, including for reasons relating to national security, chemical and biological weapons proliferation, nuclear nonproliferation, or missile technology; or

(ii) For reasons relating to regional stability or surreptitious listening;

(3) Specially designed and prepared nuclear equipment, parts and components, materials, software, and technology covered by part 810 of title 10, Code of Federal Regulations (relating to assistance to foreign atomic energy activities);

(4) Nuclear facilities, equipment, and material covered by part 110 of title 10, Code of Federal Regulations (relating to export and import of nuclear equipment and material);

(5) Select agents and toxins covered by part 331 of title 7, Code of Federal Regulations, part 121 of title 9 of such Code, or part 73 of title 42 of such Code; or

(6) Emerging and foundational technologies controlled pursuant to section 1758 of the Export Control Reform Act of 2018 (50 U.S.C. 4817).

“Interconnection arrangements” means arrangements governing the physical connection of two or more networks to allow the use of another’s network to hand off traffic where it is ultimately delivered (e.g., connection of a customer of telephone provider A to a customer of telephone company B) or sharing data and other information resources.

“Reasonable inquiry” means an inquiry designed to uncover any information in the entity’s possession about the identity of the producer or provider of covered telecommunications equipment or services used by the entity that excludes the need to include an internal or third-party audit.

“Roaming” means cellular communications services (e.g., voice, video, data) received from a visited network when unable to connect to the facilities of the home network either because signal coverage is too weak or because traffic is too high.

“Substantial or essential component” means any component necessary for the proper function or performance of a piece of equipment, system, or service.

(b) Prohibition.

(1) Section 889(a)(1)(A) of the John S. McCain National Defense Authorization Act for Fiscal Year 2019 (Pub. L. 115–232) prohibits the head of an executive agency on or after August 13, 2019, from procuring or obtaining, or extending or renewing a contract to procure or obtain, any equipment, system, or service that uses covered telecommunications equipment or services as a substantial or essential component of any system, or as critical technology as part of any system. The Contractor is prohibited from providing to the Government any equipment, system, or service that uses covered telecommunications equipment or services as a substantial or essential component of any system, or as critical technology as part of any system, unless an exception at paragraph (c) of this clause applies or the covered telecommunication equipment or services are covered by a waiver described in FAR 4.2104.

Prohibition on Contracting for Certain Telecommunications and Video Surveillance Services or Equipment

(2) Section 889(a)(1)(B) of the John S. McCain National Defense Authorization Act for Fiscal Year 2019 (Pub. L. 115–232) prohibits the head of an executive agency on or after August 13, 2020, from entering into a contract, or extending or renewing a contract, with an entity that uses any equipment, system, or service that uses covered telecommunications equipment or services as a substantial or essential component of any system, or as critical technology as part of any system, unless an exception at paragraph (c) of this clause applies or the covered telecommunication equipment or services are covered by a waiver described in FAR 4.2104. This prohibition applies to the use of covered telecommunications equipment or services, regardless of whether that use is in performance of work under a Federal contract.

(c) *Exceptions.* This clause does not prohibit contractors from providing—

(1) A service that connects to the facilities of a third-party, such as backhaul, roaming, or interconnection arrangements; or

(2) Telecommunications equipment that cannot route or redirect user data traffic or permit visibility into any user data or packets that such equipment transmits or otherwise handles.

(d) *Reporting requirement.*

(1) In the event the Contractor identifies covered telecommunications equipment or services used as a substantial or essential component of any system, or as critical technology as part of any system, during contract performance, or the Contractor is notified of such by a subcontractor at any tier or by any other source, the Contractor shall report the information in paragraph (d)(2) of this clause in writing via email to the Contracting Officer, Contracting Officer's Representative, and the Network Operations Security Center (NOSC) at NDAA_Incidents@hq.dhs.gov, with required information in the body of the email. In the case of the Department of Defense, the Contractor shall report to the website at <https://dibnet.dod.mil>. For indefinite delivery contracts, the Contractor shall report to the NOSC, Contracting Officer for the indefinite delivery contract and the Contracting Officer(s) and Contracting Officer's Representative(s) for any affected order or, in the case of the Department of Defense, identify both the indefinite delivery contract and any affected orders in the report provided at <https://dibnet.dod.mil>.

(2) The Contractor shall report the following information pursuant to paragraph (d)(1) of this clause

(i) Within one business day from the date of such identification or notification: the contract number; the order number(s), if applicable; supplier name; supplier unique entity identifier (if known); supplier Commercial and Government Entity (CAGE) code (if known); brand; model number (original equipment manufacturer number, manufacturer part number, or wholesaler number); item description; and

any readily available information about mitigation actions undertaken or recommended.

(ii) Within 10 business days of submitting the information in paragraph (d)(2)(i) of this clause: any further available information about mitigation actions undertaken or recommended. In addition, the Contractor shall describe the efforts it undertook to prevent use or submission of covered telecommunications equipment or services, and any additional efforts that will be incorporated to prevent future use or submission of covered telecommunications equipment or services.

(e) *Subcontracts*. The Contractor shall insert the substance of this clause, including this paragraph (e) and excluding paragraph (b)(2), in all subcontracts and other contractual instruments, including subcontracts for the acquisition of commercial items.

(End of clause)

52.204-24 Representation Regarding Certain Telecommunications and Video Surveillance Services or Equipment.

REPRESENTATION REGARDING CERTAIN TELECOMMUNICATIONS AND VIDEO SURVEILLANCE SERVICES OR EQUIPMENT (NOV 2021)

The Offeror shall not complete the representation at paragraph (d)(1) of this provision if the Offeror has represented that it "does not provide covered telecommunications equipment or services as a part of its offered products or services to the Government in the performance of any contract, subcontract, or other contractual instrument" in paragraph (c)(1) in the provision at 52.204-26, Covered Telecommunications Equipment or Services—Representation, or in paragraph (v)(2)(i) of the provision at 52.212-3, Offeror Representations and Certifications-*Commercial Products or Commercial Services*. The Offeror shall not complete the representation in paragraph (d)(2) of this provision if the Offeror has represented that it "does not use covered telecommunications equipment or services, or any equipment, system, or service that uses covered telecommunications equipment or services" in paragraph (c)(2) of the provision at 52.204-26, or in paragraph (v)(2)(ii) of the provision at 52.212-3.

(a) *Definitions.* As used in this provision—

Backhaul, covered telecommunications equipment or services, critical technology, interconnection arrangements, reasonable inquiry, roaming, and substantial or essential component have the meanings provided in the clause 52.204-25, Prohibition on Contracting for Certain Telecommunications and Video Surveillance Services or Equipment.

(b) *Prohibition.*

(1) Section 889(a)(1)(A) of the John S. McCain National Defense Authorization Act for Fiscal Year 2019 (Pub. L. 115-232) prohibits the head of an executive agency on or after August 13, 2019, from procuring or obtaining, or extending or renewing a contract to procure or obtain, any equipment, system, or service that uses covered telecommunications equipment or services as a substantial or essential component of any system, or as critical technology as part of any system. Nothing in the prohibition shall be construed to—

(i) Prohibit the head of an executive agency from procuring with an entity to provide
a
service that connects to the facilities of a third-party, such as backhaul, roaming, or interconnection arrangements; or

(ii) Cover telecommunications equipment that cannot route or redirect user data
traffic or
cannot permit visibility into any user data or packets that such equipment transmits or otherwise handles.

(2) Section 889(a)(1)(B) of the John S. McCain National Defense Authorization Act for Fiscal Year 2019 (Pub. L. 115-232) prohibits the head of an executive agency on or after August 13, 2020, from entering into a contract or extending or renewing a contract with an entity that uses any equipment, system, or service that uses covered telecommunications equipment or services as a substantial or essential component of any system, or as critical technology as part of any system. This prohibition applies to the use of covered telecommunications equipment or services, regardless of whether that use is in performance of work under a Federal contract. Nothing in the prohibition shall be construed to—

(i) Prohibit the head of an executive agency from procuring with an entity to provide a service that connects to the facilities of a third-party, such as backhaul, roaming, or interconnection arrangements; or

(ii) Cover telecommunications equipment that cannot route or redirect user data traffic or cannot permit visibility into any user data or packets that such equipment transmits or otherwise handles.

(c) *Procedures.* The Offeror shall review the list of excluded parties in the System for Award Management (SAM) (<https://www.sam.gov>) for entities excluded from receiving federal awards for "covered telecommunications equipment or services".

(d) *Representation.* The Offeror represents that—

(1) It will, will not provide covered telecommunications equipment or services to the Government in the performance of any contract, subcontract or other contractual instrument resulting from this solicitation. The Offeror shall provide the additional disclosure information required at paragraph (e)(1) of this section if the Offeror responds "will" in paragraph (d)(1) of this section; and

(2) After conducting a reasonable inquiry, for purposes of this representation, the Offeror represents that—

It does, does not use covered telecommunications equipment or services, or use any equipment, system, or service that uses covered telecommunications equipment or services. The Offeror shall provide the additional disclosure information required at paragraph (e)(2) of this section if the Offeror responds "does" in paragraph (d)(2) of this section.

(e) *Disclosures.*

(1) Disclosure for the representation in paragraph (d)(1) of this provision. If the Offeror has responded "will" in the representation in paragraph (d)(1) of this provision, the Offeror shall provide the following information as part of the offer:

(i) For covered equipment—

(A) The entity that produced the covered telecommunications equipment (include entity name, unique entity identifier, CAGE code, and whether the entity was the original equipment manufacturer (OEM) or a distributor, if known);

(B) A description of all covered telecommunications equipment offered (include brand; model number, such as OEM number, manufacturer part number, or wholesaler number; and item description, as applicable); and

(C) Explanation of the proposed use of covered telecommunications equipment and any factors relevant to determining if such use would be permissible under the prohibition in paragraph

(b)(1) of this provision.

(ii) For covered services—

(A) If the service is related to item maintenance: A description of all covered telecommunications services offered (include on the item being maintained: Brand; model number, such as OEM number, manufacturer part number, or wholesaler number; and item description, as applicable); or

(B) If not associated with maintenance, the Product Service Code (PSC) of the service being provided; and explanation of the proposed use of covered telecommunications services and any factors relevant to determining if such use would be permissible under the prohibition in paragraph (b)(1) of this provision.

(2) Disclosure for the representation in paragraph (d)(2) of this provision. If the Offeror has responded "does" in the representation in paragraph (d)(2) of this provision, the Offeror shall provide the following information as part of the offer:

(i) For covered equipment—

(A) The entity that produced the covered telecommunications equipment (include entity name, unique entity identifier, CAGE code, and whether the entity was the OEM or a distributor, if known);

(B) A description of all covered telecommunications equipment offered (include brand; model number, such as OEM number, manufacturer part number, or wholesaler number; and item description, as applicable); and

(C) Explanation of the proposed use of covered telecommunications equipment and any factors relevant to determining if such use would be permissible under the prohibition in paragraph

(b)(2) of this provision.

(ii) For covered services—

(A) If the service is related to item maintenance: A description of all covered telecommunications services offered (include on the item being maintained: Brand; model number, such as OEM number, manufacturer part number, or wholesaler number; and item description, as applicable); or

(B) If not associated with maintenance, the PSC of the service being provided; and explanation of the proposed use of covered telecommunications services and any factors relevant to determining if such use would be permissible under the prohibition in paragraph (b)(2) of this provision.

(End of provision)

FAA PROVISIONS

(a) General Civil Rights Provision.

Lessee agrees to comply with pertinent statutes, Executive Orders and such rules as are promulgated to ensure that no person shall, on the grounds of race, creed, color, national origin, sex, age, or disability be excluded from participating in any activity conducted with or benefiting from Federal assistance. If the Lessee transfers its obligation to another, the transferee is obligated in the same manner as the transferor.

This provision obligates the Lessee for the period during which the property is owned, used or possessed by the Lessee and the airport remains obligated to the Federal Aviation Administration. This provision is in addition to that required by Title VI of the Civil Rights Act of 1964.

(b) Compliance with Nondiscrimination Requirements.

During the performance of this contract, the Lessee, for itself, its assignees, and successors in interest (for purposes of this Section hereinafter referred to as the "Contractor"), agrees as follows:

1. **Compliance with Regulations:** The Contractor (hereinafter includes consultants) will comply with the Title VI List of Pertinent Nondiscrimination Acts and Authorities, as they may be amended from time to time, which are herein incorporated by reference and made a part of this contract.
2. **Nondiscrimination:** The Contractor, with regard to the work performed by it during the contract, will not discriminate on the grounds of race, color, or national origin in the selection and retention of subcontractors, including procurements of materials and leases of equipment. The Contractor will not participate directly or indirectly in the discrimination prohibited by the Nondiscrimination Acts and Authorities, including employment practices when the contract covers any activity, project, or program set forth in Appendix B of 49 CFR part 21.
3. **Solicitations for Subcontracts, including Procurements of Materials and Equipment:** In all solicitations, either by competitive bidding or negotiation made by the Contractor for work to be performed under a subcontract, including procurements of materials, or leases of equipment, each potential subcontractor or supplier will be notified by the Contractor of the contractor's obligations under this contract and the Nondiscrimination Acts and Authorities on the grounds of race, color, or national origin.
4. **Information and Reports:** The Contractor will provide all information and reports required by the Acts, the Regulations, and directives issued pursuant thereto and will permit access to its books, records, accounts, other sources of information, and its facilities as may be determined by the Lessor (for purposes of this Section hereinafter referred to as the "sponsor") or the Federal Aviation Administration to be pertinent to ascertain compliance with such Nondiscrimination Acts and Authorities and instructions. Where any information required of a contractor is in the exclusive possession of another who fails or refuses to furnish the information, the Contractor will so certify to the sponsor or the

Federal Aviation Administration, as appropriate, and will set forth what efforts it has made to obtain the information.

5. **Sanctions for Noncompliance:** In the event of a Contractor's noncompliance with the non-discrimination provisions of this contract, the sponsor will impose such contract sanctions as it or the Federal Aviation Administration may determine to be appropriate, including, but not limited to:
 - a. Withholding payments to the Contractor under the contract until the Contractor complies; and/or
 - b. Cancelling, terminating, or suspending a contract, in whole or in part.
6. **Incorporation of Provisions:** The Contractor will include the provisions of paragraphs one through six in every subcontract, including procurements of materials and leases of equipment, unless exempt by the Acts, the Regulations, and directives issued pursuant thereto. The Contractor will take action with respect to any subcontract or procurement as the sponsor or the Federal Aviation Administration may direct as a means of enforcing such provisions including sanctions for noncompliance. Provided, that if the Contractor becomes involved in, or is threatened with litigation by a subcontractor, or supplier because of such direction, the Contractor may request the sponsor to enter into any litigation to protect the interests of the sponsor. In addition, the Contractor may request the United States to enter into the litigation to protect the interests of the United States.

(c) Affirmative Action.

Lessee assures that it will undertake an affirmative action program as required by 14 CFR Part 152, Subpart E, and any amendments thereto, and any other federal statutes or regulations applicable to the receipt of federal assistance from the Department of Transportation by local governments for Airport use, or otherwise applicable to persons leasing premises from the City of El Paso, to insure that no person shall, on the grounds of race, color, sex, age, disability or national origin be excluded from participating in or receiving the services or benefits of any program of activity covered by this Subpart. Lessee assures that it will require that its covered sub-organizations (sublessees) provide assurances to Lessor, as set forth herein, that they similarly will undertake affirmative action programs, and that they will require assurance from their sub-organizations (sublessees) to the same effect.

(d) FAA Order 1400.11.

Pursuant to Federal Aviation Administration Order 1400.11, effective August 27, 2013, and because the described premises are located at the El Paso International Airport which is subject to regulation by, among others, the U.S. Federal Aviation Administration, the parties specifically agree to the following:

1. A. Tenant for itself, its successors in interest and assigns, as a part of the consideration hereof, does hereby covenant and agree, as a covenant running with the land, that in the event facilities are constructed, maintained, or otherwise operated on the property described in this Lease for a purpose for which a Federal Aviation Administration activity, facility, or program is extended or for another purpose involving the provision of similar

services or benefits, Lessee will maintain and operate such facilities and services in compliance with all requirements imposed by the Nondiscrimination Acts and Regulations listed in Pertinent List of Nondiscrimination Authorities (Federal Aviation Administration Order 1400.11, Appendix 4) as same may be amended from time to time (the "Acts and Regulations") such that no person on the grounds of race, color, or national origin, will be excluded from participation in, denied the benefits of, or be otherwise subjected to discrimination in the use of said facilities.

B. With respect to the Lease, in the event of breach of any of the above nondiscrimination covenants, Landlord will have the right to terminate the Lease and to enter or re-enter and repossess said Premises and the facilities thereon, and hold the same as if said instrument had never been made or issued. [FAA Order 1400.11, Appendix C]

2. A. The Tenant for itself, its successors in interest and assigns, as a part of the consideration hereof, does hereby covenant and agree, as a covenant running with the land, that (1) no person on the ground of race, color, or national origin, will be excluded from participation in, denied the benefits of, or be otherwise subjected to discrimination in the use of said facilities, (2) that in the construction of any improvements on, over, or under such land, and the furnishing of services thereon, no person on the ground of race, color, or national origin, will be excluded from participation in, denied the benefits of, or otherwise be subjected to discrimination, (3) that the Tenant will use the premises in compliance with all other requirements imposed by or pursuant to the listed acts and authorities appearing in the Acts and Regulations.

B. With respect to the Lease, in the event of breach of any of the above nondiscrimination covenants, Landlord will have the right to terminate the Lease and to enter or re-enter and repossess said Premises and the facilities thereon, and hold the same as if said instrument had never been made or issued. [FAA Order 1400.11, Appendix D]

3. A. During the term of this Lease, Tenant for itself, its assignees, and successors in interest, as a part of the consideration hereof, agrees to comply with the following non-discrimination statutes and authorities; including but not limited to:

- Title VI of the Civil Rights Act of 1964 (42 USC § 2000d *et seq.*, 78 stat. 252), (prohibits discrimination on the basis of race, color, national origin);
- 49 CFR part 21 (Non-discrimination in Federally-assisted programs of the Department of Transportation-Effectuation of Title VI of the Civil Rights Act of 1964);
- The Uniform Relocation Assistance and Real Property Acquisition Policies Act of 1970, (42 USC § 4601) (prohibits unfair treatment of persons displaced or whose property has been acquired because of Federal or Federal-aid programs and projects);
- Section 504 of the Rehabilitation Act of 1973 (29 USC § 794 *et seq.*), as amended, (prohibits discrimination on the basis of disability); and 49 CFR part 27;
- The Age Discrimination Act of 1975, as amended, (42 USC § 6101 *et seq.*) (prohibits discrimination on the basis of age);

EXHIBIT K

- Airport and Airway Improvement Act of 1982 (49 USC§ 471, Section 47123), as amended (prohibits discrimination based on race, creed, color, national origin, or sex);
- The Civil Rights Restoration Act of 1987 (PL 100-209) (broadened the scope, coverage and applicability of Title VI of the Civil Rights Act of 1964, the Age Discrimination Act of 1975 and Section 504 of the Rehabilitation Act of 1973, by expanding the definition of the terms "programs or activities" to include all of the programs or activities of the Federal-aid recipients, sub-recipients and contractors, whether such programs or activities are Federally funded or not);
- Titles II and III of the Americans with Disabilities Act of 1990, which prohibit discrimination on the basis of disability in the operation of public entities, public and private transportation systems, places of public accommodation, and certain testing entities (42 USC §§ 12131 - 12189) as implemented by Department of Transportation regulations at 49 CFR parts 37 and 38;
- The Federal Aviation Administration's Non-discrimination statute (49 USC § 47123) (prohibits discrimination on the basis of race, color, national origin, and sex);
- Executive Order 12898, Federal Actions to Address Environmental Justice in Minority Populations and Low-Income Populations, which ensures discrimination against minority populations by discouraging programs, policies, and activities with disproportionately high and adverse human health or environmental effects on minority and low-income populations;
- Executive Order 13166, Improving Access to Services for Persons with Limited English Proficiency, and resulting agency guidance, national origin discrimination includes discrimination because of limited English proficiency (LEP). Grantee shall take reasonable steps to ensure that LEP persons have meaningful access to its programs (70 Fed. Reg. at 74087 to 74100);
- Title IX of the Education Amendments of 1972, as amended, which prohibits discrimination because of sex in education programs or activities (20 USC 1681 *et seq.*).

B. In the event of breach of any of the covenants in this section 3, Landlord shall have the rights and remedies set forth in sections 1 and 2 above, in addition to all other rights and remedies available to it under applicable law. [FAA Order 1400.11, Appendix E]